

# VX400

## All-in-One Controller



User Manual

# Change History

---

Document Version	Release Date	Description
V1.0.0	2022-08-30	First release

# Contents

---

1 Overview .....	1
2 Appearance .....	1
3 Applications .....	4
4 Home Screen .....	6
4.1 Home Screen .....	6
4.2 Second Home Screen .....	7
5 Menu Operations .....	8
5.1 Screen Brightness .....	8
5.2 Screen Configuration .....	9
5.2.1 Quick Configuration .....	9
5.2.2 Send Cabinet Configuration File .....	10
5.2.3 Save to RV Card .....	11
5.2.4 Advanced Configuration .....	12
5.2.5 Mapping .....	12
5.2.6 LED Screen Color .....	13
5.2.7 Output Frame Rate .....	14
5.3 Layer Settings .....	14
5.3.1 Add Layers .....	15
5.3.2 Switch Layer Input Sources .....	16
5.3.3 Input Crop .....	17
5.3.4 Adjust Layer Opacity .....	17
5.4 Input Settings .....	18
5.4.1 Set Input Resolution .....	18
5.4.2 Set Input Source Color .....	19
5.4.3 View Color Space .....	20
5.4.4 Set Color Range .....	20
5.4.5 Configure Mosaic Sources .....	20
5.5 Preset Settings .....	21
5.5.1 Save Presets .....	22
5.5.2 Load Presets .....	22
5.5.3 Clear Presets .....	22
5.5.4 Copy Presets .....	22
5.5.5 Rename Presets .....	23
5.6 Image Mosaic .....	23
5.7 Display Control .....	24
5.8 Advanced Settings .....	25
5.8.1 Device Backup .....	25
5.8.2 Input Backup .....	28
5.8.3 Synchronization .....	29
5.8.4 HDMI Output .....	29
5.8.5 Audio .....	30
5.8.5.1 Output .....	31
5.8.5.2 Volume .....	32
5.8.6 Input HDCP .....	32
5.8.7 Low Latency .....	32
5.8.8 OPT 2 Mode .....	32
5.9 System Settings .....	33

5.9.1 Fn..... 34

5.9.2 Return to Home (s)..... 34

5.9.3 Diagnostics..... 34

5.9.4 About..... 34

5.10 Factory Reset ..... 35

5.11 Communication Settings ..... 35

    5.11.1 Set Communication Mode ..... 35

    5.11.2 Set Network Parameters ..... 36

5.12 Working Mode..... 37

5.13 Language..... 37

6 Device Update..... 38

    6.1 Obtain Firmware Update Package ..... 38

    6.2 Firmware Update ..... 38

7 Device Backup/Restore..... 40

    7.1 Device Backup..... 40

    7.2 Device Restore ..... 40

8 Screen Brightness Adjustment ..... 40

9 Specifications ..... 44

10 Video Source Features..... 45

11 Notes and Cautions ..... 45

# 1 Overview

The VX400 is NovaStar's new all-in-one controller that integrates video processing and video control into one box. It features 4 Ethernet ports and supports video controller, fiber converter and Bypass working modes. A VX400 unit can drive up to 2.6 million pixels, with the maximum output width and height up to 10,240 pixels and 8192 pixels respectively, which is ideal for ultra-wide and ultra-high LED screens.

The VX400 is capable of receiving a variety of video signals and processing high-resolution images. In addition, the device features stepless output scaling, low latency, pixel-level brightness and chroma calibration and more, to present you with an excellent image display experience.

What's more, the VX400 can work with NovaStar's supreme software NovaLCT and V-Can to greatly facilitate your in-field operations and control, such as screen configuration, Ethernet port backup settings, layer management, preset management and firmware update.

Thanks to its powerful video processing and sending capabilities and other outstanding features, the VX400 can be widely used in applications such as medium and high-end rental, stage control systems and fine-pitch LED screens.

# 2 Appearance

## Front Panel

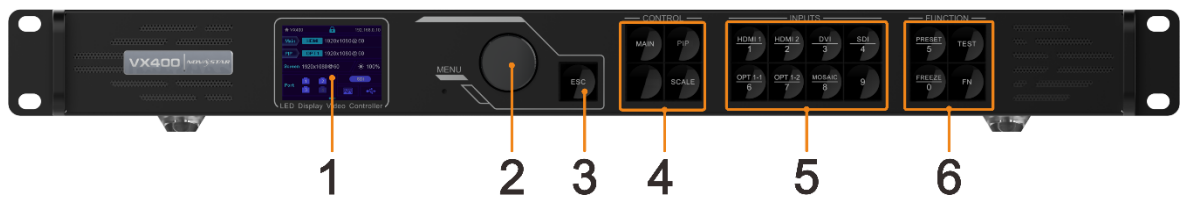

No.	Area	Function
1	LCD screen	Display the device status, menus, submenus and messages.
2	Knob	<ul style="list-style-type: none"> <li>Rotate the knob to select a menu item or adjust the parameter value.</li> <li>Press the knob to confirm the setting or operation.</li> </ul>
3	ESC button	Exit the current menu or cancel an operation.
4	Control area	<ul style="list-style-type: none"> <li>MAIN/PIP: Open or close a layer, and show the layer status. Status LEDs:                             <ul style="list-style-type: none"> <li>On (blue): The layer is opened.</li> <li>Flashing (blue): The layer is being edited.</li> <li>On (white): The layer is closed.</li> </ul> </li> <li>SCALE: A shortcut button for the full screen function. Press the button to make the layer of the lowest priority fill the entire screen. Status LEDs:                             <ul style="list-style-type: none"> <li>On (blue): Full screen scaling is turned on.</li> <li>On (white): Full screen scaling is turned off.</li> </ul> </li> </ul>
5	Input source buttons	Show the input source status and switch the layer input source. Status LEDs: <ul style="list-style-type: none"> <li>On (blue): An input source is accessed.</li> <li>Flashing (blue): The input source is not accessed but used by the layer.</li> <li>On (white): The input source is not accessed or the input source is abnormal.</li> </ul> <b>Notes:</b> <ul style="list-style-type: none"> <li>When a 4K video source is connected to OPT 1, OPT 1-1 has a signal but</li> </ul>

No.	Area	Function
		<p>OPT 1-2 does not have a signal.</p> <ul style="list-style-type: none"> <li>When two 2K video sources are connected to OPT 1, OPT 1-1 and OPT 1-2 both have a 2K signal.</li> </ul>
6	Shortcut function buttons	<ul style="list-style-type: none"> <li>PRESET: Access the preset settings menu.</li> <li>TEST: Access the test pattern menu.</li> <li>Freeze: Freeze the output image.</li> <li>FN: A customizable button</li> </ul>

**Notes:**

- Hold down the knob and **ESC** button simultaneously for 3s or longer to lock or unlock the front panel buttons.
- This product can only be placed horizontally. Do not mount vertically or upside-down.
- The product can be mounted in a standard 19-inch rack capable of withstanding at least four times the total weight of the mounted equipment. Four M5 screws should be used to fix the product.

Rear Panel



Input Connectors		
Connector	Qty	Description
3G-SDI	1	<ul style="list-style-type: none"> <li>ST-424 (3G), ST-292 (HD) and ST-259 (SD) standard video inputs supported</li> <li>Max. input resolution: 1920x1080@60Hz</li> <li>Deinterlacing processing supported</li> <li>3G-SDI loop output supported</li> <li>DOES NOT support input resolution and bit depth settings.</li> </ul>
HDMI 1.3	2	<ul style="list-style-type: none"> <li>Max. input resolution: 1920x1200@60Hz</li> <li>HDCP 1.4 compliant</li> <li>DOES NOT support interlaced signal inputs</li> <li>Custom resolutions supported                             <ul style="list-style-type: none"> <li>Max. width: 3840 (3840x648@60Hz)</li> <li>Max. height: 2784 (800x2784@60Hz)</li> <li>Forced inputs supported: 600x3840@60Hz</li> </ul> </li> <li>Loop output supported on HDMI 1.3-1</li> </ul>
DVI	1	<ul style="list-style-type: none"> <li>Max. input resolution: 1920x1200@60Hz</li> <li>HDCP 1.4 compliant</li> <li>DOES NOT support interlaced signal inputs</li> <li>Custom resolutions supported                             <ul style="list-style-type: none"> <li>Max. width: 3840 (3840x648@60Hz)</li> <li>Max. height: 2784 (800x2784@60Hz)</li> <li>Forced inputs supported: 600x3840@60Hz</li> </ul> </li> <li>Loop output supported on DVI.</li> </ul>

Output Connectors		
Connector	Qty	Description
Ethernet ports	4	<p>Gigabit Ethernet ports</p> <ul style="list-style-type: none"> <li>• Max. loading capacity: 2.6 million pixels</li> <li>• Max. width: 10,240 pixels</li> <li>• Max. height: 8192 pixels</li> </ul> <p>Ethernet ports 1 and 2 support audio output. When you use a multifunction card to parse the audio, be sure to connect the card to Ethernet port 1 or 2.</p> <p>Status LEDs:</p> <ul style="list-style-type: none"> <li>• The top left one (green) indicates the connection status. <ul style="list-style-type: none"> <li>– On: The port is well connected.</li> <li>– Flashing: The port is not well connected, such as loose connection.</li> <li>– Off: The port is not connected.</li> </ul> </li> <li>• The top right one (yellow) indicates the communication status. <ul style="list-style-type: none"> <li>– On: The Ethernet cable is short-circuited.</li> <li>– Flashing: The communication is good and data is being transmitted.</li> <li>– Off: No data transmission</li> </ul> </li> </ul>
HDMI 1.3	1	<ul style="list-style-type: none"> <li>• Support monitor and video output modes.</li> <li>• The output resolution is adjustable.</li> </ul>
Optical Fiber Ports		
Connector	Qty	Description
OPT	2	<ul style="list-style-type: none"> <li>• OPT 1: Self-adaptive, either for video input or for output <ul style="list-style-type: none"> <li>– When the device is connected with a fiber converter, the port is used as an output connector.</li> <li>– When the device is connected with a video processor, the port is used as an input connector.</li> <li>– Max. capacity: 1x 4Kx1K@60Hz or 2x 2Kx1K@60Hz video inputs</li> </ul> </li> <li>• OPT 2: For output only, with copy and backup modes OPT 2 copies or backs up the output on 4 Ethernet ports.</li> </ul>
Control Connectors		
Connector	Qty	Description
ETHERNET	1	<p>Connect to the control PC or router.</p> <p>Status LEDs:</p> <ul style="list-style-type: none"> <li>• The top left one indicates the connection status. <ul style="list-style-type: none"> <li>– On: The port is well connected.</li> <li>– Flashing: The port is not well connected, such as loose connection.</li> <li>– Off: The port is not connected.</li> </ul> </li> <li>• The top right one indicates the communication status. <ul style="list-style-type: none"> <li>– On: The Ethernet cable is short-circuited.</li> <li>– Flashing: The communication is good and data is being transmitted.</li> <li>– Off: No data transmission</li> </ul> </li> </ul>
LIGHT SENSOR	1	Connect to a light sensor to collect the ambient brightness, allowing for automatic screen brightness adjustment
USB	2	<ul style="list-style-type: none"> <li>• USB (Type-B): <ul style="list-style-type: none"> <li>– Connect to the control PC or used as the input connector for device cascading</li> </ul> </li> </ul>

		• USB (Type-A): Output connector for device cascading
--	--	---

**Note:**

Only the main layer can use the mosaic source. When the main layer uses the mosaic source, the PIP layer cannot be opened.

### 3 Applications

- Work as a video controller:

The HDMI output connector is used for monitoring.

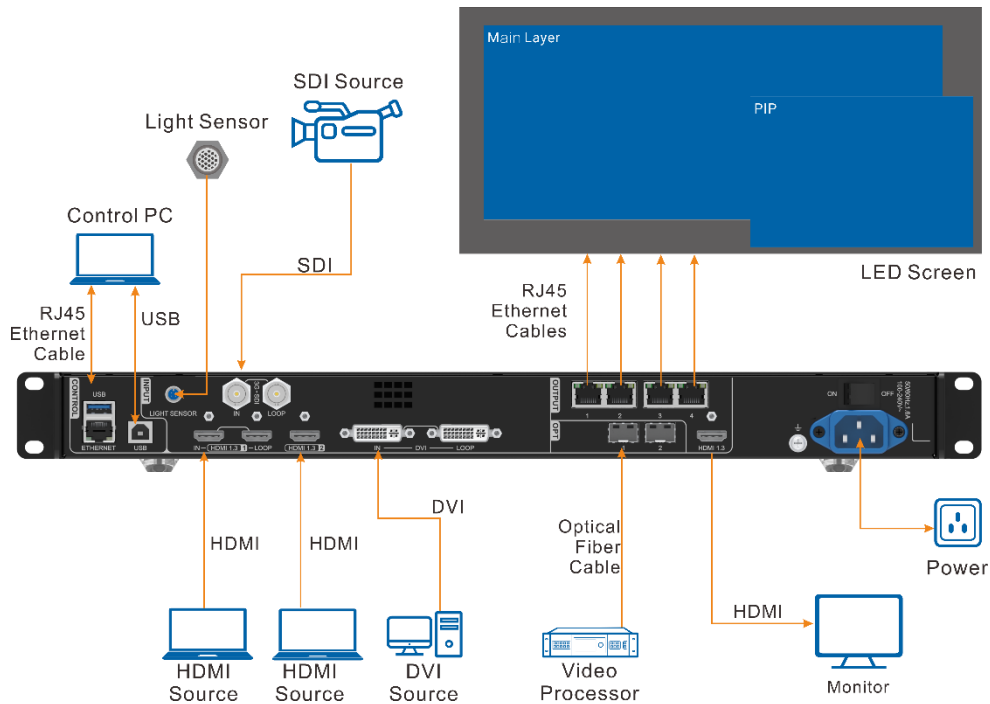

- Work in Bypass mode:

The VX400 works as an independent LED display controller. The output image will not be processed and will be displayed in pixel-to-pixel. In this mode, only the main layer can be used, but the PIP layer is unavailable.



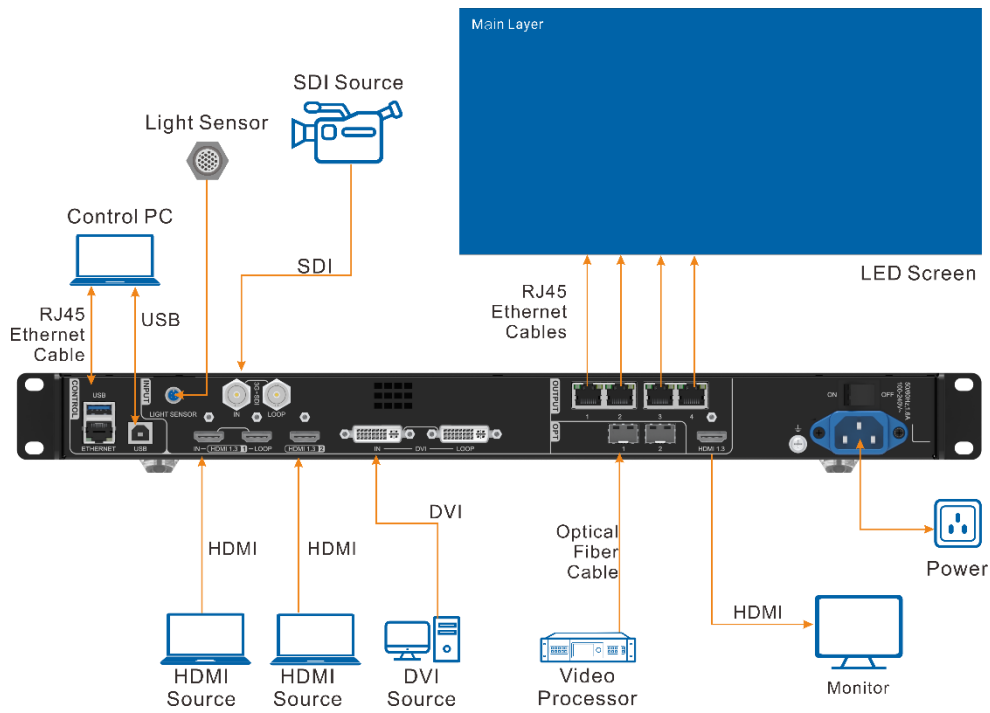

- Work as a fiber convert for long-distance transmission

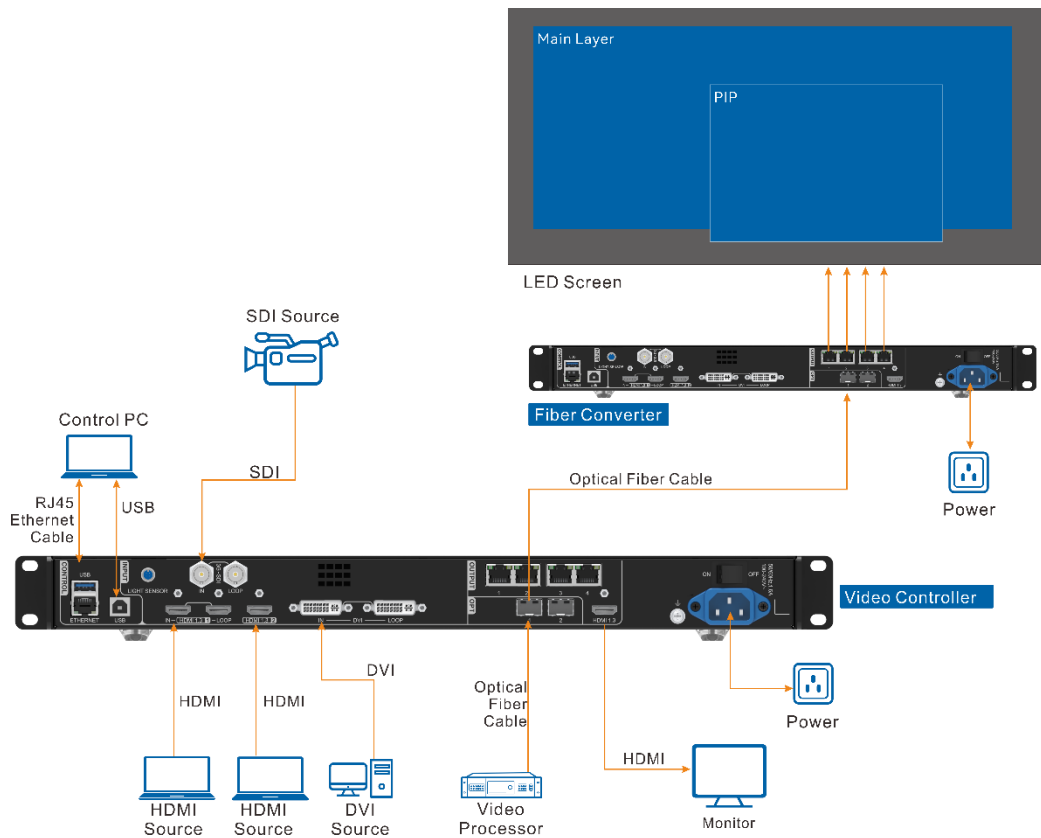

**Note:**

In long-distance transmission, either OPT 1 or OPT 2 can be used. When OPT 2 is used, switch its working mode to **Copy**.









# 4 Home Screen

## 4.1 Home Screen

Figure 4-1 Home screen



Icon	Description
VX400	The device name
192.168.0.10	The device IP address
<ul style="list-style-type: none"> <li>• Main</li> <li>• PIP</li> </ul>	The layer input source and resolution
Screen	The current screen resolution
☀️	The screen brightness, 0% (black) to 100% (brightest)
Port	<p>The Ethernet port number and port status</p> <ul style="list-style-type: none"> <li>• : The Ethernet port is connected and serves as the primary output port.</li> <li>• : The Ethernet port is not connected.</li> <li>• : The Ethernet port is connected and serves as the backup output port.</li> </ul> <p>When  at the bottom right flashes, there is data transmission on the port.</p>
Synchronization	<p>The sync status and sync source</p> <ul style="list-style-type: none"> <li>• : The sync function is enabled and the synchronization succeeded. Sync source: SDI</li> <li>• : The sync function is enabled and the synchronization is in progress. Sync source: SDI</li> <li>• : The sync function is enabled but the synchronization failed. Sync source: SDI</li> <li>• : The sync function is not enabled. SDI indicates the sync source you used last time.</li> </ul>

Icon	Description
Display control	<p>The output image status</p> <ul style="list-style-type: none"> <li> : The output image is displayed.</li> <li> : The output is black.</li> <li> : The output image is frozen.</li> <li> : The test pattern is shown.</li> </ul>
Connection method	<ul style="list-style-type: none"> <li> : The device is connected to the control PC via an Ethernet port.</li> <li> : The device is not connected to the control PC.</li> <li> : The device is connected to the control PC via a USB port.</li> <li> : The device is in cascading mode via a USB port.</li> </ul>

## 4.2 Second Home Screen

The second home screen page displays the working and connection statuses of the OPT ports and the working and connection statuses of the Ethernet ports on the fiber converter connected to the VX400. On the home screen, rotate the knob to access the second home screen page.

This page may vary slightly according to the different working modes of OPT 2.

**Note:**

This page is available when the OPT ports are connected.

Figure 4-2 OPT 2 copy mode



- Master > Port: Display the connection and backup statuses of the Ethernet ports of the VX400.
- Copy > OPT2: OPT 2 works in Copy mode. Display the connection and backup statuses of the Ethernet ports on the fiber converter connected to the VX400.

Figure 4-3 OPT 2 backup mode



- Master > Port: Display the connection and backup statuses of the Ethernet ports of the VX400.
- Copy > OPT2: OPT 2 works in Backup mode. Display the connection and backup statuses of the Ethernet ports on the fiber converter connected to the VX400.

## 5 Menu Operations

### Operating Instructions

- Knob:
  - On the home screen, press the knob to enter the operation menu screen.
  - On the operation menu screen, rotate the knob to select a menu item and press the knob to confirm the selection or enter the submenu.
  - When a menu item with parameters is selected, you can rotate the knob to adjust the parameters. Please note that after the adjustment, you need to press the knob again to confirm the adjustment.
- **ESC**: Exit the current menu or cancel an operation.
- Hold down the knob and ESC button simultaneously for 3s or longer to lock or unlock the front panel buttons.

After the settings, if you need to shut down the device, please wait at least 5 seconds; otherwise, the parameter settings may not be saved.

### 5.1 Screen Brightness

Screen brightness allows you to adjust the LED screen brightness in an eye-friendly way according to the current ambient illuminance. Besides, appropriate adjustment of screen brightness can extend the service life of the LED screen.

Figure 5-1 Screen brightness

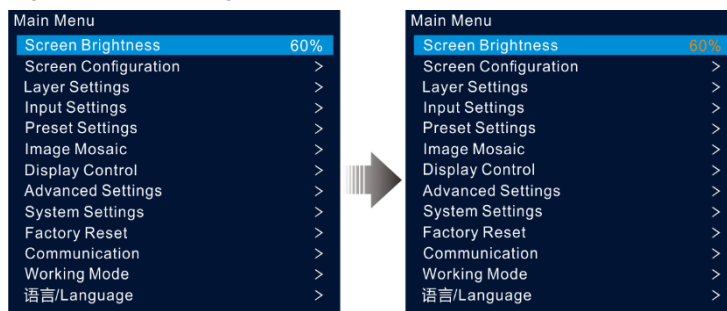

- Step 1 On the home screen, press the knob to enter the main menu screen.
- Step 2 Select **Screen Brightness** and press the knob to confirm the selection.
- Step 3 Rotate the knob to adjust the brightness value. You can see the adjustment result on the LED screen in real time. Press the knob to apply the brightness you set when you are satisfied with it.

## 5.2 Screen Configuration

Screen configuration allows you to perform the following operations, including configuring the screen, sending the cabinet configuration file, saving configuration to the receiving card, changing LED screen color, setting output frame rate and output mapping.

On the home screen, press the knob to enter the main menu screen. Rotate the knob to select **Screen Configuration** and press the knob to enter the screen configuration screen.

Figure 5-2 Screen configuration

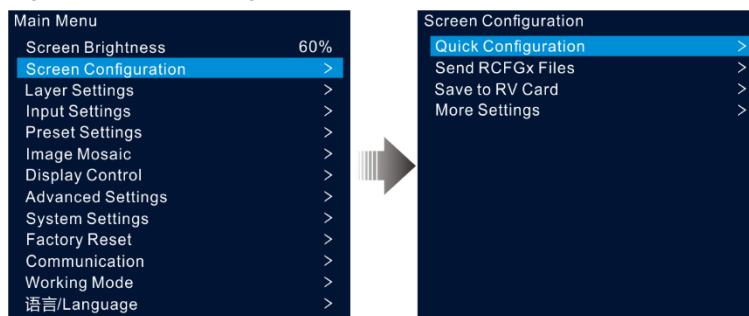

### 5.2.1 Quick Configuration

When the LED screen is a regular one composed of cabinets from the same batch, you can use the quick configuration function to configure the LED screen.

#### Prerequisites

- The LED screen must be a regular one.
- The cabinets of the screen must be regular cabinets with the same resolution.
- The following data flow settings are supported. During data flow settings, ensure that each port's physical connection is along the same direction and downward to the next one.
- During data flow settings, ensure that Ethernet Port 1 is at the beginning of the actual physical connection.

Figure 5-3 Data flow



## Operating Procedure

- Step 1 On the main menu screen, rotate the knob to go to **Screen Configuration > Quick Configuration** to enter the quick configuration screen.
- Step 2 Set **Cabinet Row Qty** and **Cabinet Column Qty** according to the cabinets' actual row and column quantities.

Figure 5-4 Quick configuration

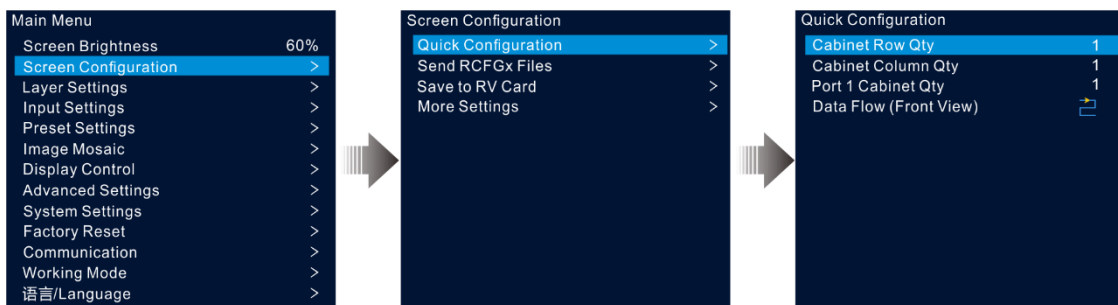

- Step 3 Rotate the knob to select **Port 1 Cabinet Qty** to set the quantity of the cabinets loaded by Ethernet port 1.

### Notes:

- Cabinets loaded by Ethernet port 1 ≥ Cabinets loaded by Ethernet port 2 ≥ Cabinets loaded by Ethernet port 3 ≥ Cabinets loaded by Ethernet port 4
- The number of cabinets loaded by each Ethernet port must be an integer multiple of **Cabinet Row Qty** or **Cabinet Column Qty** of the screen.
- The total pixels of the cabinets loaded by Ethernet port 1 cannot exceed 650,000.

- Step 4 Rotate the knob to select **Data Flow (Front View)** and press the knob to confirm. Select a physical connection for the cabinets.

During data flow settings, you can see the result on the LED screen in real-time. If the entire screen displays content correctly, that is, no overlapping or repetition, press the knob to save the settings.

## 5.2.2 Send Cabinet Configuration File

After the LED screen is powered on, if a cabinet or the whole LED screen cannot be lit, you can update the configuration file in the cabinet and re-light the cabinet by using this function. Then you can perform the screen configuration and the screen can display the output image as usual.

The cabinet configuration file is a file with the suffix ".rcfgx", which stores the module, cabinet, data flow information and more.

## Add Cabinet Configuration File

- Step 1 Run the NovalCT software. On the menu bar, go to **User > Advanced Synchronous System User Login** and log in.

Figure 5-5 Log in to NovaLCT

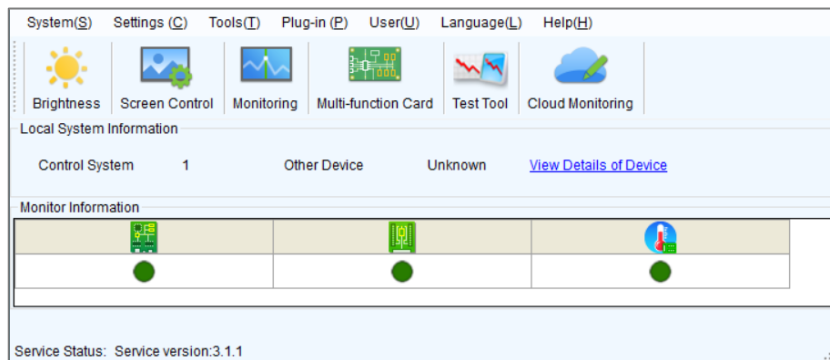

- Step 2 Go to **Tools > Controller Cabinet Configuration File Import** to enter the controller cabinet configuration file importing page.

Figure 5-6 Import cabinet configuration file

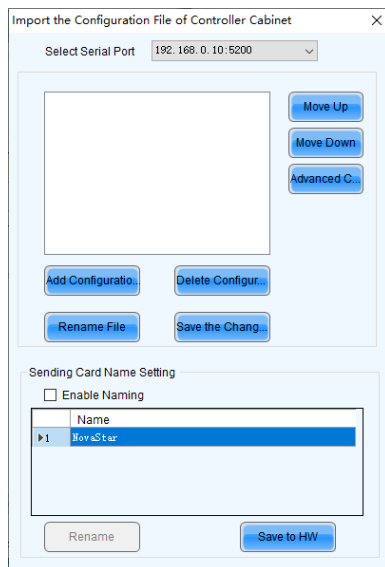

- Step 3 Click **Add Configuration File** and select the desired file from the window that appears.

- Step 4 Click **Save the Change to HW** to save the configuration file to the device.

## Send Cabinet Configuration File

After you have added the cabinet configuration file to the device via NovaLCT, you can send the configuration file to the receiving cards in the cabinets of the LED screen.

- Step 1 On the main menu screen, rotate the knob to go to **Screen Configuration > Send RCFGx Files**.
- Step 2 Rotate the knob to select the desired configuration file and press the knob to confirm. The system will automatically send the selected file to all the receiving cards of the LED screen.

### 5.2.3 Save to RV Card

After the screen configuration information is sent to the receiving card, you can save the configuration to the card so that the configuration data will not be lost after a power failure.

On the main menu screen, go to **Screen Configuration > Save to RV Card** and press the knob to confirm.

## 5.2.4 Advanced Configuration

You can set the cabinet row and column quantities, horizontal offset, vertical offset and data flow of the cabinets loaded by a single Ethernet port.

- Step 1 On the main menu screen, go to **Screen Configuration > More Settings > Advanced Configuration** to enter the advanced configuration screen.
- Step 2 Set the status to **On** to enable the advanced configuration function.

Figure 5-7 Advanced configuration

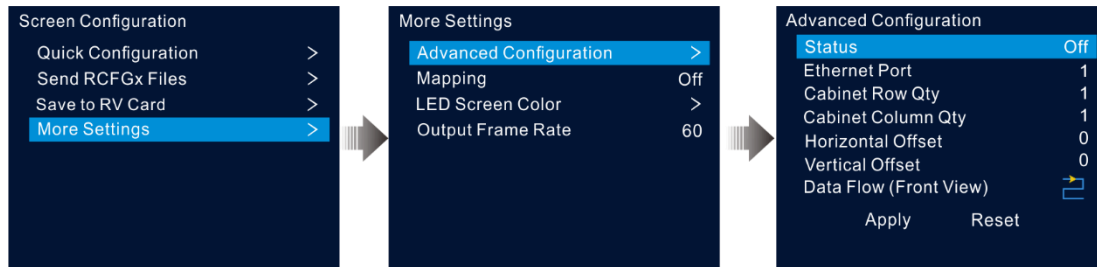

- Step 3 Select the desired Ethernet port.
- Step 4 Set the row and column quantities of the cabinets loaded by the current Ethernet port.
- Step 5 Set the horizontal and vertical offsets of the first cabinet loaded by the current Ethernet port.

The offset value indicates the distance between the top left corner of the loading area and the top left corner of the whole screen. The offset value unit is pixel.

- Step 6 Select the desired data flow for the cabinets.

## 5.2.5 Mapping

Mapping is used to show the relations between the cabinets of the LED screen and the sending devices so that you can view or check the connections between the cabinets.

### Note:

The receiving cards that are connected to the device must support the Mapping function. For the supported models of the receiving cards, please visit our official website at [www.novastar.tech](http://www.novastar.tech).

On the main menu screen, go to **Screen Configuration > More Settings > Mapping** and turn on the function.



Figure 5-8 Mapping



P:05 indicates the Ethernet port number of the sending device.  
 #001 shows the number of the cabinet loaded by the Ethernet port.

### 5.2.6 LED Screen Color

This function allows you to adjust the color temperature and Gamma value of the LED screen to make the images displayed on the screen more clear and vivid.

On the main menu screen, go to **Screen Configuration > More Settings > LED Screen Color** to enter the screen color settings screen.

- Select **Gamma** and press the knob to confirm. Rotate the knob to adjust the Gamma value and press the knob to confirm when you are satisfied with it.
- Rotate the knob to select **Temperature** and press the knob to confirm. Rotate the knob to adjust the temperature mode, including **Standard**, **Cool**, **Warm** and **Custom**, and then press the knob to confirm when you are satisfied with it.

When **Custom** is selected, you can customize the color temperature by adjusting the R, G and B values individually.

Figure 5-9 LED screen color

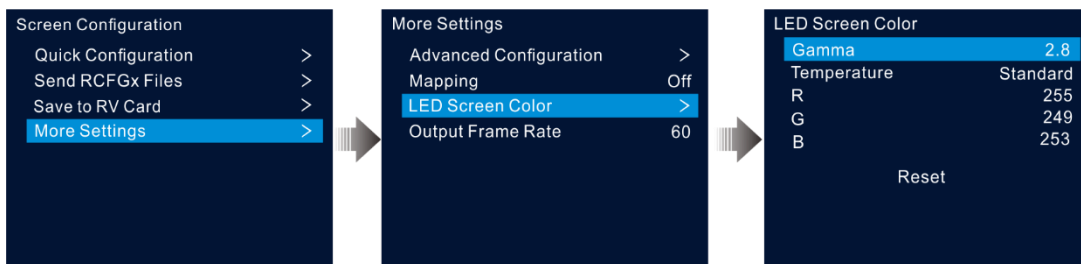

Table 5-1 LED color parameter descriptions

Parameter	Description
Gamma	Adjust the image distortion degree from the input to output. The greater the value is, the more distorted the image will be. The value ranges from 0.25 to 4.00 and defaults to 2.8.

Temperature	Adjust the cool or warm degree of images displayed on the LED screen. When <b>Custom</b> is selected, you can customize the color temperature by adjusting the R, G and B values individually.
-------------	--

### 5.2.7 Output Frame Rate

This function allows you to set the frame rate of the output. The frame rate defaults to 60 Hz.

On the main menu screen, go to **Screen Configuration > More Settings > Output Frame Rate**. Rotate the knob to select the desired frame rate and press the knob to confirm.

The supported frame rates include 23.98 Hz, 24 Hz, 25 Hz, 29.97 Hz, 30 Hz, 47.95 Hz, 48 Hz, 50 Hz, 59.94 Hz, 60 Hz, 72 Hz, 75 Hz, 85 Hz, 100 Hz, and 120 Hz.

## 5.3 Layer Settings

The VX400 supports two layers. The layer properties and settings are shown in [Table 5-2](#).

Table 5-2 Layer properties

Menu	Description
Status	Open or close the layer. The main layer is opened and the PIP layer is closed by default.
Input source	Select an input source for the current layer. <b>Note:</b> Press an input source button in the <b>SOURCE</b> area on the device front panel to quickly select an input source for the layer.
Scaling Mode	The layer supports the following three scaling modes. <ul style="list-style-type: none"> <li>• Full Screen: The layer image fills the whole screen.</li> <li>• Pixel to Pixel: The layer image is not scaled but displayed in the original size of the input source or the cropped source.</li> <li>• Custom: Customize the layer size and the output image is scaled according to the layer size.</li> </ul>
H Width	Set the layer size in the horizontal direction. The width value ranges from 64 to 32768.
V Height	Set the layer size in the vertical direction. The height value ranges from 64 to 32768.
Initial X	Set the horizontal distance between the top left corner of the layer and the top left corner of the screen.
Initial Y	Set the vertical distance between the top left corner of the layer and the top left corner of the screen.
Priority	Adjust the layer z-order. The greater the value, the more front the layer. The value ranges from 1 to 3. <ul style="list-style-type: none"> <li>• 1: The layer locates at the bottom.</li> <li>• 3: The layer locates on the top.</li> </ul>
Input Crop	Crop the input source image and display the cropped part on full screen. <ul style="list-style-type: none"> <li>• Status: Turn on or turn off the cropping function.</li> <li>• H Width: The size of the cropped part in the horizontal direction. The value ranges from 64 to the width of the current input source.</li> <li>• V Height: The size of the cropped part in the vertical direction. The value ranges from</li> </ul>

Menu	Description
	64 to the height of the current input source. <ul style="list-style-type: none"> <li>• Initial X: Set the start position for the cropping in the horizontal direction. The value defaults to 0.</li> <li>• Initial Y: Set the start position for the cropping in the vertical direction. The value defaults to 0.</li> </ul>
Opacity	Set the transparent degree of the layer image. The greater the value, the more opaque the layer image; the smaller the value, the more transparent the layer image. <ul style="list-style-type: none"> <li>• 0%: Transparent</li> <li>• 100%: Nontransparent</li> </ul>

### 5.3.1 Add Layers

#### Button Operations

- Step 1 Press the **MAIN** and **PIP** button in the **CONTROL** area on the device front panel to quickly open the layer and the device screen displays the corresponding layer settings screen.
- MAIN: Main layer
  - PIP: PIP layer
- Step 2 Press an input source button in the **INPUTS** area to quickly select an input source for the layer.

#### Menu Operations

- Step 1 On the home screen, press the knob to enter the main menu screen.
- Step 2 Rotate the knob to select **Layer Settings** and press the knob to enter the layer settings screen.
- Step 3 Rotate the knob to select **Main Layer** or **PIP** and press the knob to enter the corresponding settings screen.

Figure 5-10 Layer settings

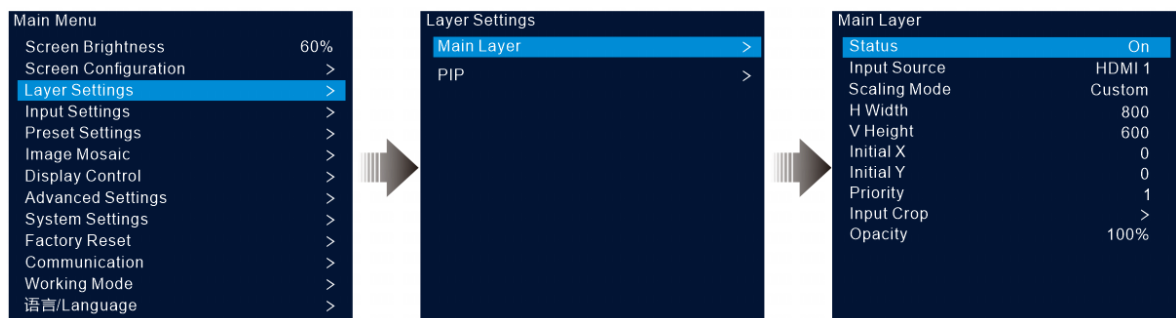

- Step 4 Select **Status** and press the knob to confirm. Rotate the knob again to select **On** and press the knob to confirm.
- Step 5 Rotate the knob to select **Input Source** and select the desired input source for the layer.
- Step 6 Rotate the knob to select other layer parameters and set them if needed. The layer parameter descriptions are shown in [Table 5-2](#) and [Figure 5-11](#).

Figure 5-11 Layer parameter descriptions



Step 7 Rotate the knob to select **Priority** and set the layer z-order.

### 5.3.2 Switch Layer Input Sources

#### Button Operations

Step 1 Press the **MAIN** or **PIP** button in the **CONTROL** area on the device front panel to quickly open the layer and the device screen displays the corresponding layer settings screen.

After pressed, the layer button becomes flashing.

Step 2 Press an input source button in the **INPUTS** area to quickly switch the layer input source.

Figure 5-12 Switch layer input sources

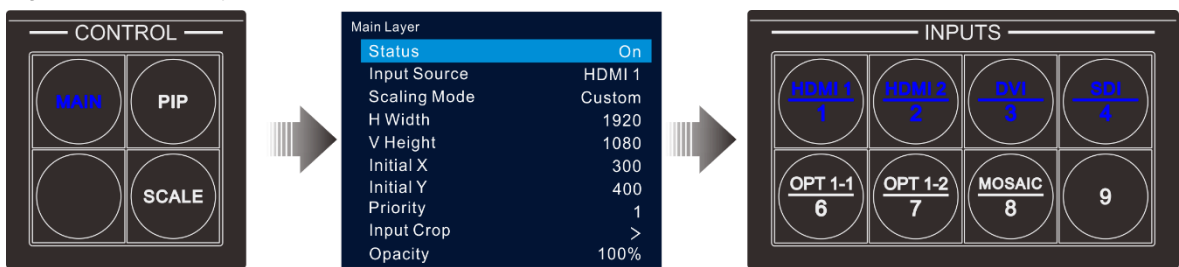

**Notes:**

- When switching the input source of the main layer, you do not need to press the **MAIN** button first. Press an input source button directly.
- Press the **SCALE** button to make the bottom layer fill the whole screen quickly.

#### Menu Operations

Step 1 On the home screen, press the knob to enter the main menu screen.

Step 2 Go to **Layer Settings > Main Layer/PIP > Input Source** to enter the input source settings screen.

Step 3 Rotate the knob to select the target input source and press the knob to confirm.

### 5.3.3 Input Crop

This function allows you to crop the input source image and make the cropped part display on full screen.

Step 1 On the home screen, press the knob to enter the main menu screen.

Step 2 Go to **Layer Settings > Main Layer/PIP > Input Crop** to enter the input source cropping screen.

Step 3 Select **Status** and press the knob to confirm. Rotate the knob again to select **On** and press the knob to confirm.

Step 4 Rotate the knob to select other cropping parameters and set them if needed. The cropping parameter descriptions are shown in [Table 5-2](#) and [Figure 5-14](#).

Figure 5-13 Input crop

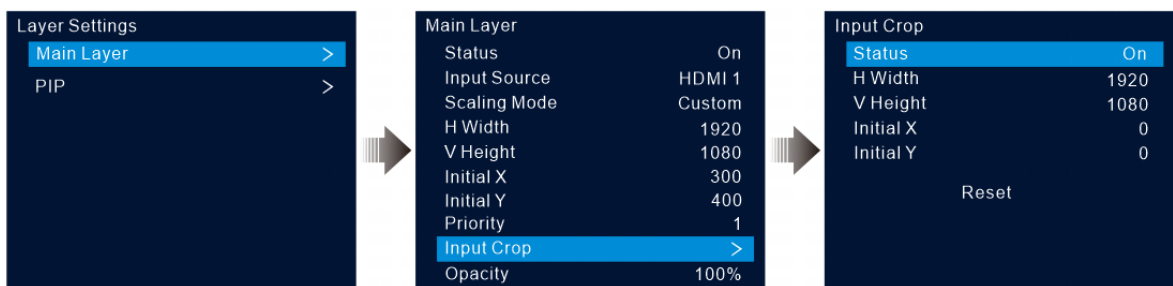
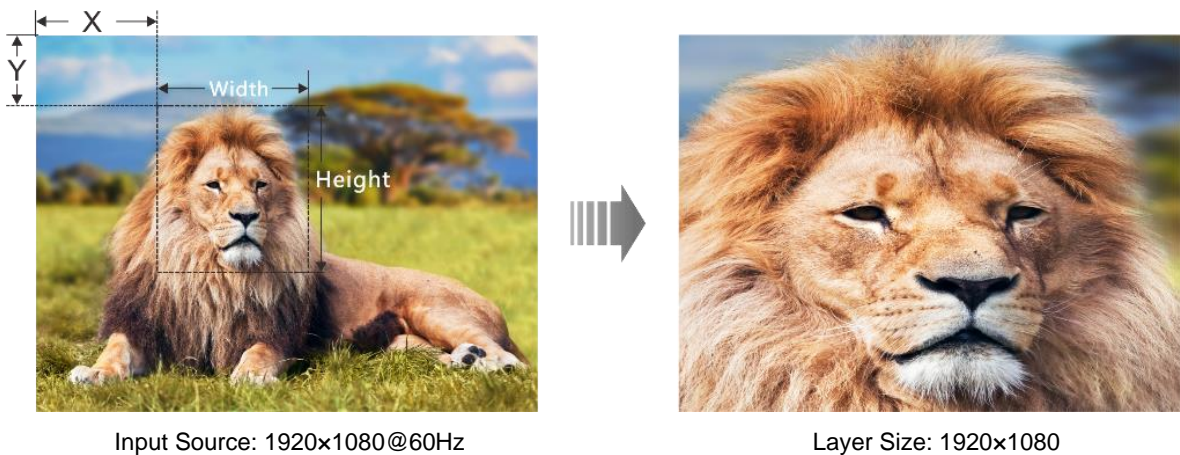

Figure 5-14 Input crop effect



### 5.3.4 Adjust Layer Opacity

Adjust the layer opacity according to your own needs.

Step 1 On the main menu screen, go to **Layer Settings > Main Layer/PIP > Opacity**.

Step 2 Rotate the knob to adjust the opacity percentage and press the knob to confirm.

When the opacity percentage is adjusted, the output image shows the opaque effect in real-time. The PIP layer opacity is 60% in [Figure 5-15](#).

Figure 5-15 Opacity

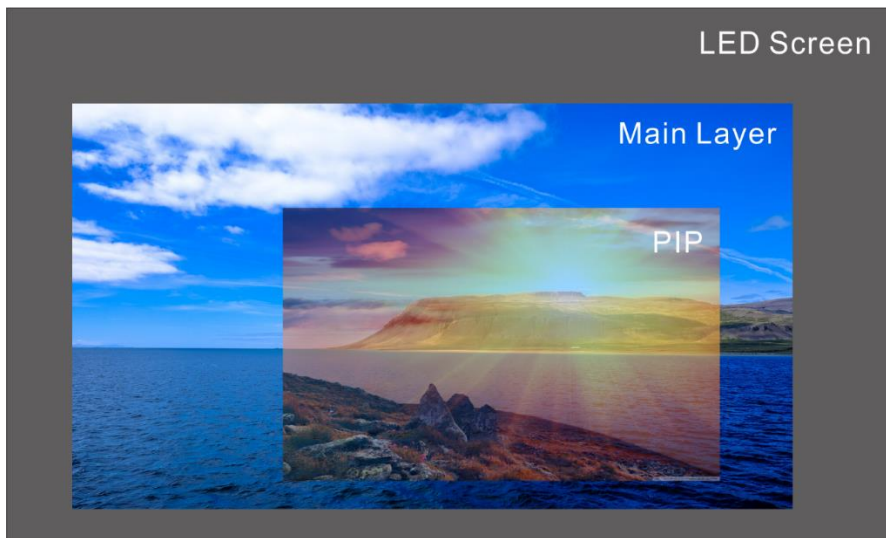

## 5.4 Input Settings

On the main menu screen, rotate the knob to select **Input Settings** and press the knob to enter the input source screen.

Figure 5-16 Select input source

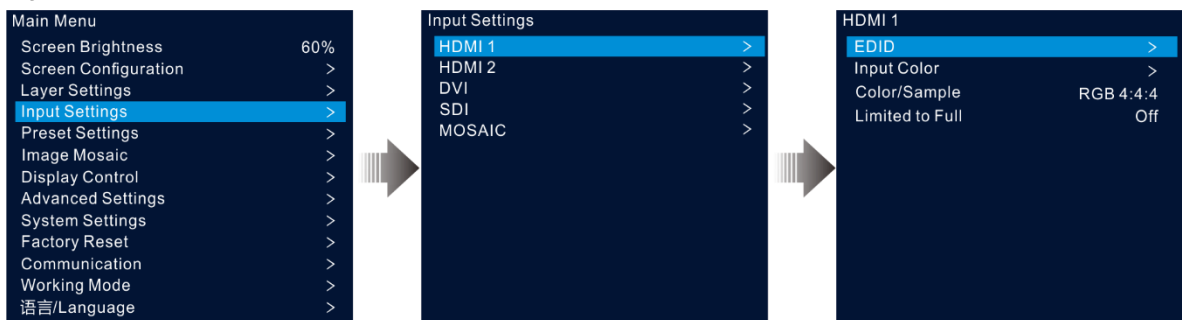

### 5.4.1 Set Input Resolution

The VX400 provides the HDMI, DVI and 3G-SDI (optional) input connectors.

When a DVI or HDMI input source is output by a graphics card, the resolution settings are supported. The following two methods are provided to set the input resolution:

- Standard resolution
- Custom resolution

**Note:**

The SDI input source does not support resolution settings.

#### Standard Resolution

- Step 1 On the input settings screen, select the desired input source and press the knob to enter the input resolution settings screen.
- Step 2 Select **EDID** and press the knob to enter the EDID settings screen.

- Step 3 Set the EDID mode to **Standard**.
- Step 4 Rotate the knob to select **Resolution**, and press the knob to show the resolution list.
- Step 5 Rotate the knob to select the desired resolution from the list and then press the knob to confirm.
- Step 6 Rotate the knob to select **Frame Rate**, and press the knob to show the frame rate list.
- Step 7 Rotate the knob to select the desired frame rate from the list and then press the knob to confirm.

Figure 5-17 Standard resolution

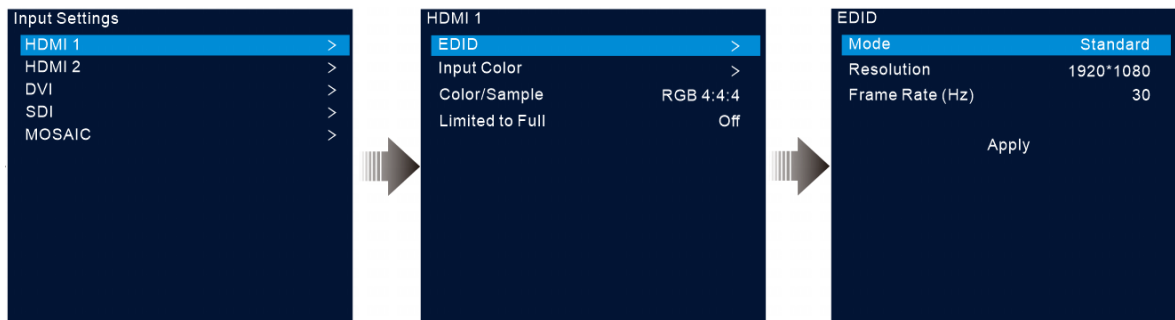

- Step 8 Rotate the knob to select **Apply** and press the knob to complete the standard resolution settings.

## Custom Resolution

- Step 1 On the input settings screen, select the desired input source and press the knob to enter the input resolution settings screen.
- Step 2 Select **EDID** and press the knob to enter the EDID settings screen.
- Step 3 Set the EDID mode to **Custom**.
- Step 4 Rotate the knob to select **Width** and press the knob to confirm. Rotate the knob again to select the desired width and press the knob to confirm.
- Step 5 Rotate the knob to select **Height** and press the knob to confirm. Rotate the knob again to select the desired height and press the knob to confirm.
- Step 6 Rotate the knob to select **Frame Rate** and press the knob to show the frame list. Rotate the knob again to select the desired frame rate and press the knob to confirm.

Figure 5-18 Custom resolution

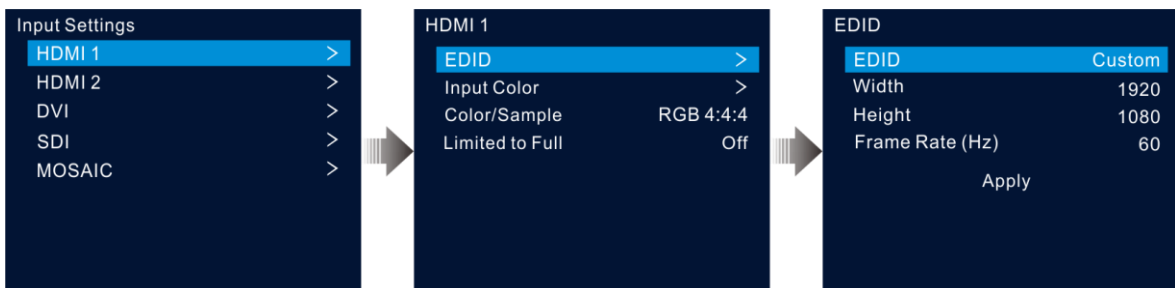

### 5.4.2 Set Input Source Color

On the input settings screen, select the desired input source and press the knob to enter the input resolution settings screen. Rotate the knob to select **Input Color** and press the knob to enter the input color settings screen. The color parameter descriptions are shown in [Table 5-3](#).

Figure 5-19 Input color

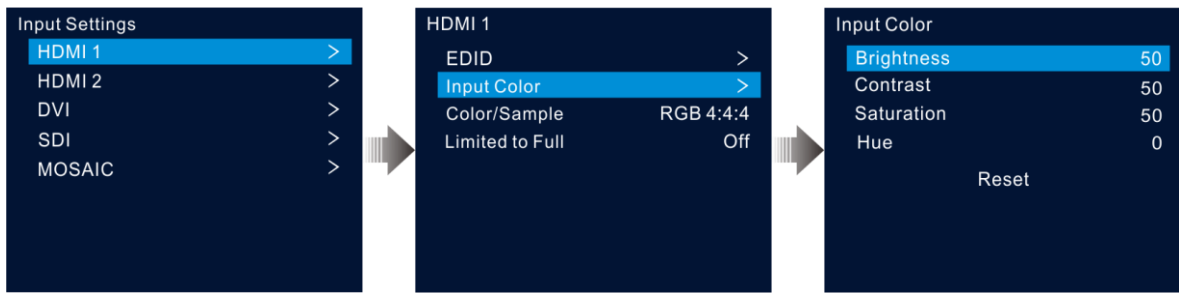

Table 5-3 Input color parameters

Menu	Description
Brightness	Adjust the brightness or darkness of an input source image. The value ranges from 0 to 100 and defaults to 50.
Contrast	Adjust the difference in brightness between light and dark areas of an input source image. The value ranges from 0 to 100 and defaults to 50.
Saturation	Adjust the strength or purity of the colors of an input source image. The larger the saturation, the more vivid the input source image; the smaller the saturation, the larger the image grayscale. The value ranges from 0 to 100 and defaults to 50.
Hue	Adjust the distinction between colors (white, black and gray tones are not included). The value ranges from -180 to +180 and defaults to 0.
Reset	Reset the input color parameters to factory defaults.

### 5.4.3 View Color Space

View the color space and sampling rate of the current input source, which are automatically read by the system and cannot be set.

### 5.4.4 Set Color Range

The input source color range includes RGB Full and RGB Limited. This function automatically converts the color range of the input source from RGB Limited to RGB Full, allowing for more accurate video processing.

- Off: Do not convert RGB Limited to RGB Full.
- On: Convert RGB Limited to RGB Full. You are advised to turn on this function when the input source has a limited color range.

### 5.4.5 Configure Mosaic Sources

The VX400 supports a mosaic source composed of two input sources accessed to OPT 1.



- Step 1 On the input settings screen, rotate the knob to select **MOSAIC** and press the knob to enter the mosaic source settings screen.

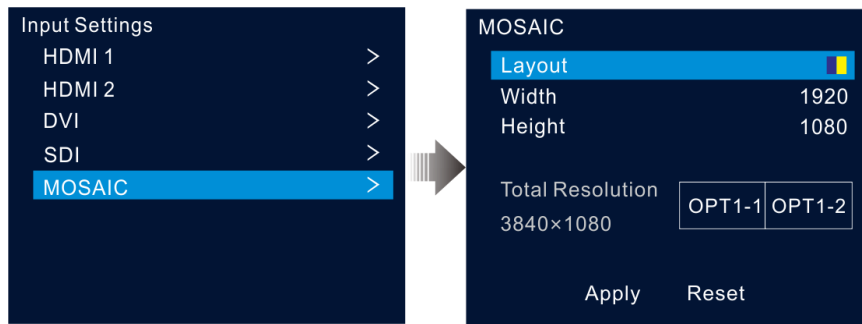

Figure 5-20 Mosaic



Step 2 Select the desired mosaic layout.

Two layout templates are supported:  and .

Step 3 Set **Width** and **Height** for each mosaic area.

Both the width and height values range from 64 to 2048 pixels.

- If the input source width or height is less than the width or height value you set, the blank area will be filled with solid black.
- If the input source width or height is larger than the width or height value you set, the input source image will be cropped. The cropping takes the top left corner of the input source image as the reference point and then crops the image according to the set width and height values.

Step 4 Rotate the knob to select the total resolution line, and press the knob to confirm. Then rotate the knob again to set the mosaic source.

---

#### Notes:

- When you change the mosaic layout and size, the total resolution changes accordingly in real-time. The total resolution indicates the size of the mosaic source.
  - You can only set the mosaic source in the left/top rectangle, while the source on the right/bottom will be set accordingly.
- 

Step 5 Rotate the knob to select **Apply** to make the settings take effect; otherwise, select **Reset** to reset the settings to defaults.

---

#### Note:

After a PIP layer is opened, the mosaic source cannot be used. Only the main layer can use the mosaic source.

---

## 5.5 Preset Settings

A preset is a set of parameters that save the layer and layer-related information. The VX400 supports ten user-defined presets. After a preset is saved, you can load the preset simply by its name. The preset operations include Save, Load, Clear and Copy To.

On the home screen, press the knob to enter the main menu screen. Rotate the knob to select **Preset Settings** and press the knob to enter the preset settings screen.

Figure 5-21 Preset settings



### 5.5.1 Save Presets

After the layer settings, you can save those settings as a preset.

- Step 1 On the preset settings screen, rotate the knob to select a preset.
- Step 2 Press the knob to open the preset operations window.
- Step 3 Rotate the knob to select **Save** and press the knob to save the layer settings to this preset.

After a preset is saved, the preset status on the right side changes to **Saved**.

#### Note:

The layer settings data include the layer status, input source, size, initial position, priority, input cropping, opacity and input source color.

### 5.5.2 Load Presets

This operation allows you to send a saved preset to an LED screen.

- Step 1 On the preset settings screen, rotate the knob to select a saved preset.
- Step 2 Press the knob to open the preset operations window.
- Step 3 Rotate the knob to select **Load** and press the knob to load the preset.

After a preset is loaded, the preset status on the right side changes to **In Use**.

### 5.5.3 Clear Presets

This operation allows you to clear the data saved in the preset. The preset name will not be cleared. After a preset is cleared, the preset status on the right side changes to **Blank**.

- Step 1 On the preset settings screen, rotate the knob to select a saved preset.
- Step 2 Press the knob to open the preset operations window.
- Step 3 Rotate the knob to select **Clear** and press the knob to open a confirmation window.
- Step 4 Rotate the knob to select **Yes** and press the knob to clear the preset.

### 5.5.4 Copy Presets

This operation allows you to copy the layer data in a saved preset to another preset.

- Step 1 On the preset settings screen, rotate the knob to select a saved preset.
- Step 2 Press the knob to open the preset operations window.

- Step 3 Rotate the knob to select **Copy To** and press the knob to go back to the preset settings screen.
- Step 4 Rotate the knob to select the target preset and press the knob to confirm.
- After the copying, the status of the target preset changes to **Saved**.

### 5.5.5 Rename Presets

The VX400 allows you to rename the presets in V-Can. After a successful renaming, the new name will be shown on the device screen.

---

#### Note:

For the exact method and steps of how to rename a preset in V-Can, please refer to *V-Can User Manual*.

---

## 5.6 Image Mosaic

When the pixel count of an LED screen is larger than the load capacity of a single VX400 unit, the image mosaic function is required. You can use multiple device units together to load the LED screen.

### Prerequisites

Before using the image mosaic function, ensure that you turn on the synchronization function on each device and all the devices use the same input source as the sync source.

Figure 5-22 Connection method for image mosaic

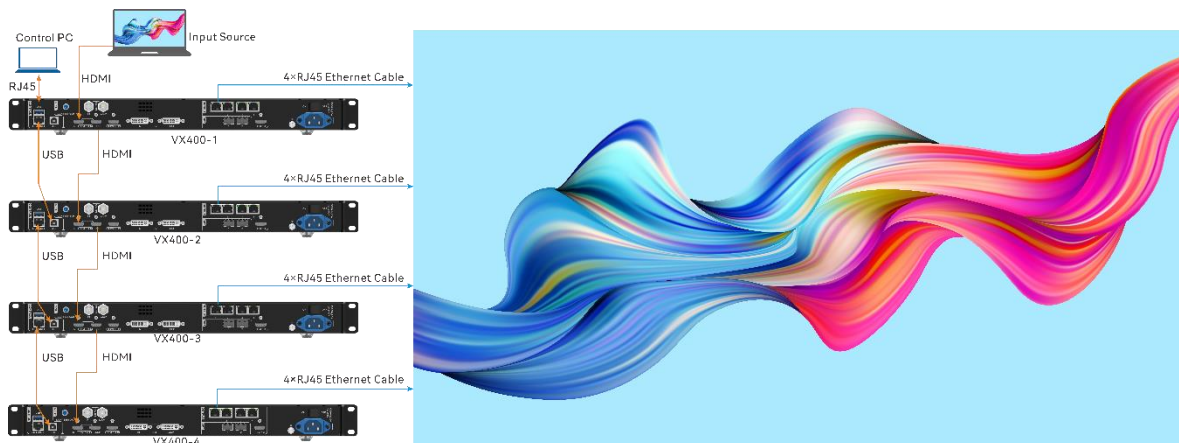

### Notes

After the image mosaic function is turned on, the full screen scaling and pixel to pixel display of the layer are unavailable.

### Operating Procedure

- Step 1 On the main menu screen, rotate the knob to select **Image Mosaic** and press the knob to enter the image mosaic settings screen.
- Step 2 Rotate the knob to select **Status** and press the knob to confirm. Rotate the knob again to select **On** and press the knob to confirm.

Figure 5-23 Image mosaic

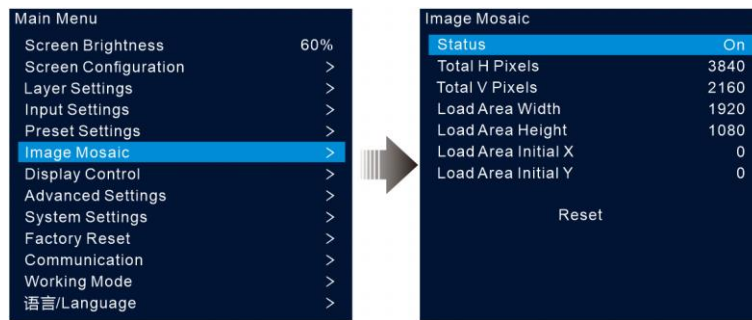

Step 3 Set the mosaic-related parameters for each device.

- Total H Pixels: The number of pixels in the horizontal direction of the LED screen
- Total V Pixels: The number of pixels in the vertical direction of the LED screen
- Load Area Width: The number of pixels in the horizontal direction of the area loaded by the current device
- Load Area Height: The number of pixels in the vertical direction of the area loaded by the current device
- Load Area Initial X: The initial horizontal coordinate of the top-left corner of the area loaded by the current device. The unit is pixel.
- Load Area Initial X: The initial vertical coordinate of the top-left corner of the area loaded by the current device. The unit is pixel.

## 5.7 Display Control

On the main menu screen, rotate the knob to select **Display Control** and press the knob to enter the display control settings screen.

Figure 5-24 Display control

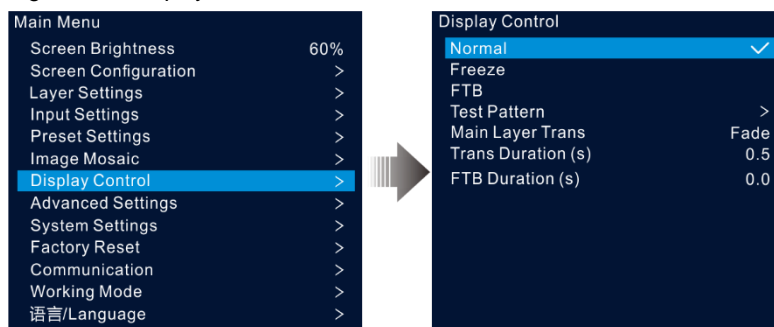

- Normal: Display the content of the current input source.
- Freeze: Freeze the current frame of the output image.
- FTB: Make the output image fade to black.
- Test Pattern: Display the test pattern on the screen.

The test patterns are used to test the display effect of the LED screen and the working status of each LED. The test patterns include **Pure Color**, **Gradient**, **Grid** and more.

- Main Layer Trans: Set the animation presented when the input source of the main layer is being switched to another. Currently, **Fade** and **Cut** are supported.
- Trans Duration (s): Set the time length the transition effect lasts. When **Main Layer Trans** is set to **Fade**, this option is available. The value ranges from 0 to 2.0 and defaults to 0.5.
- FTB Duration (s): Set the time length the FTB process lasts. The value ranges from 0 to 2.0 and defaults to 0.

**Note:**

If the freeze or FTB function is turned on, the test pattern function is unavailable.

## 5.8 Advanced Settings

The advanced settings allow you to set the device backup, input source backup, synchronization, HDMI output, audio, input source HDCP, low latency and OPT 2 working mode.

### 5.8.1 Device Backup

The VX400 supports both the backup between devices and Ethernet ports.

#### Backup Between Devices

Device backup allows you to set the backup relationship between two devices. You can set one of the devices as the primary device or the backup device. When the primary device has a problem or the primary device's Ethernet cable fails, the backup device will take over the responsibilities of the primary device seamlessly and continue to work well to ensure the LED screen will not go black.

- The connection diagram for the device backup:

Figure 5-25 Device backup connection

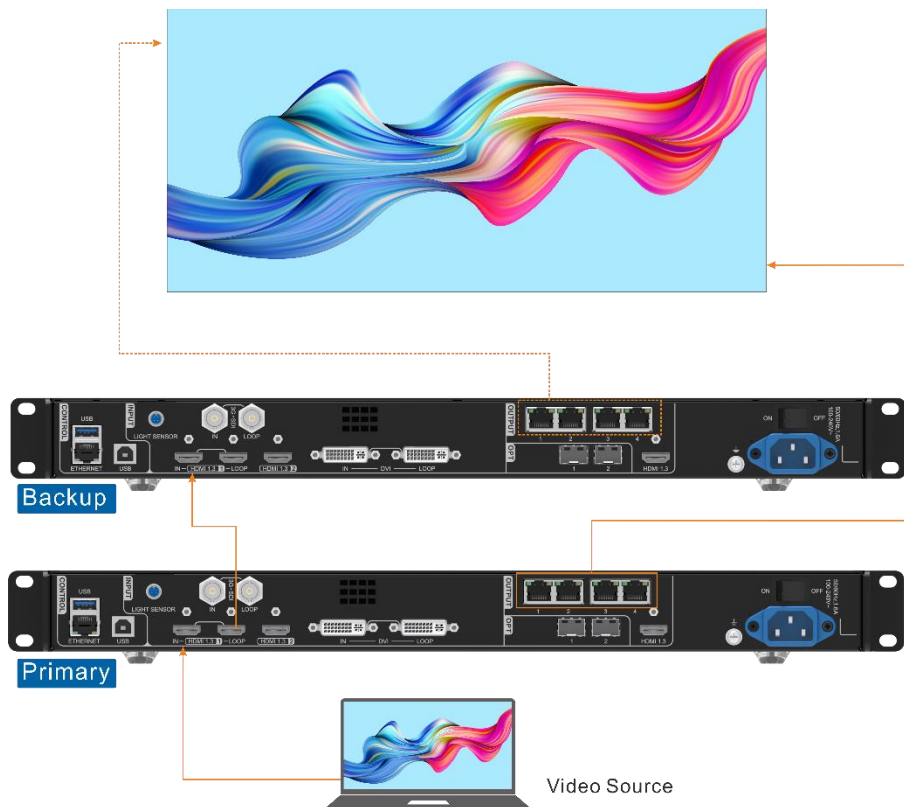

- The setting procedure for the device backup:

Step 1 On the main menu screen, go to **Advanced Settings > Device Backup** to enter the device backup screen.

Figure 5-26 Device Backup

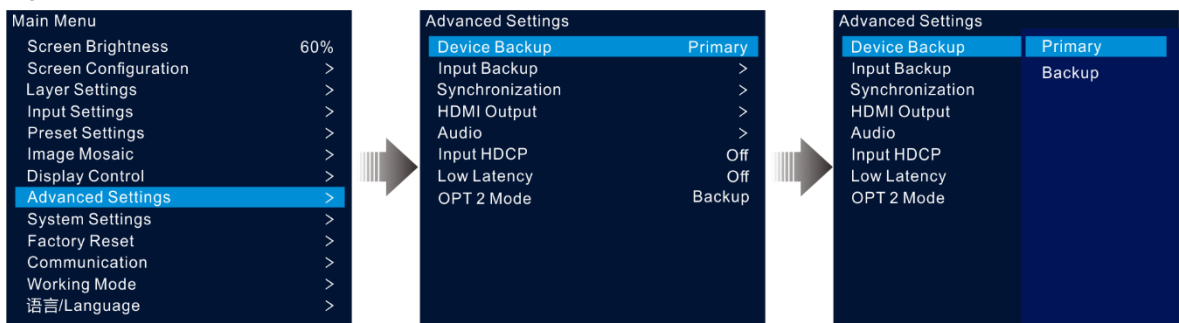

Step 2 Rotate the knob to select **Primary**.

Follow the same procedure to set the other device as **Backup**.

**Notes:**

- In the device backup mode, the quantity of the cabinets loaded by each Ethernet port on both the primary and backup devices must be the same, but their data flow must be in a reversed way.
- The layers and layer property settings on both the primary and backup devices must be the same.

### Backup between Ethernet Ports

Ethernet port backup allows you to set the backup relationship between two Ethernet ports. When the primary port has a problem or the primary port's Ethernet cable fails, the backup port will take over the responsibilities of the primary port seamlessly and continue to work well to ensure the LED screen will not go black. When setting the backup between the Ethernet ports, you need to complete it in NovaLCT.

- The connection diagram for the Ethernet port backup:

Figure 5-27 Ethernet port backup connection

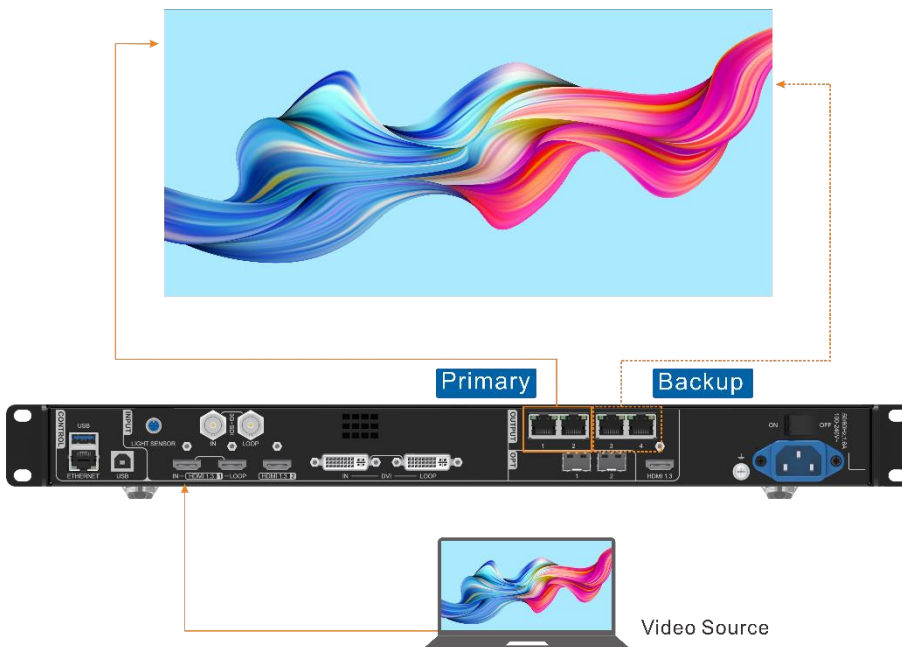

- The setting procedure for the Ethernet port backup:

Step 1 Run the NovaLCT software. On the menu bar, go to **User > Advanced Synchronous System User Login**. Enter the password and click **Login**.

- Step 2 Click **Screen Configuration** to enter the screen configuration page.
- Step 3 Click **Next** to enter the screen configuration page.

Figure 5-28 Screen configuration

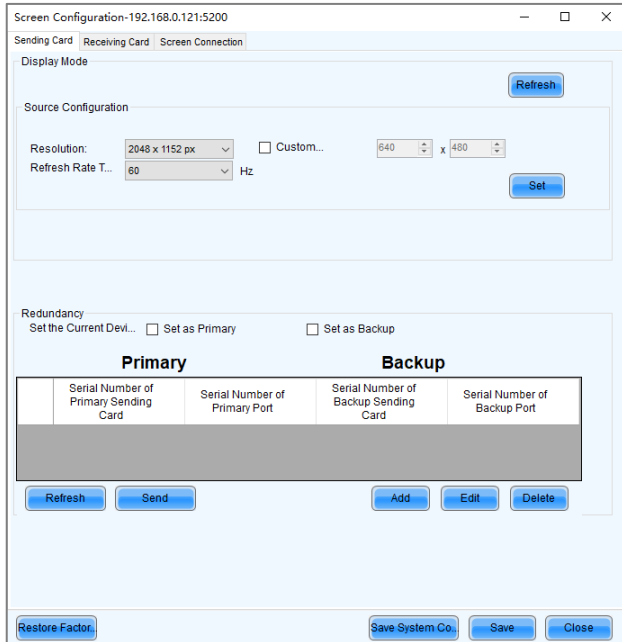

- Step 4 Select the **Sending Card** tab, and then click **Add** in the **Redundancy** area.
- Step 5 Set the serial numbers of both the primary device and backup device to **1**.
- Step 6 Set the serial number of the primary port and the serial number of the corresponding backup port.

Figure 5-29 Ethernet port backup

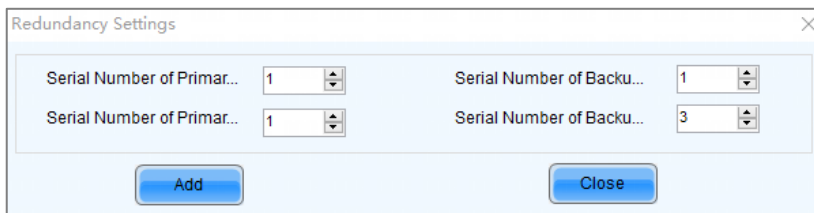

- Step 7 Click **Add** to complete the backup settings of an Ethernet port, and the system will automatically list the primary ports and backup ports.

Figure 5-30 Primary Ethernet ports



Step 8 Repeat Step 6 and Step 7 to complete the backup settings for other Ethernet ports.

### 5.8.2 Input Backup

Input backup allows you to set the backup relationship between two input sources. When one input source has a problem or the input connector fails, the backup source will be used seamlessly and continue to work well to ensure the LED screen will not go black.

Step 1 On the main menu screen, go to **Advanced Settings > Input Backup** to enter the input backup settings screen.

Figure 5-31 Input source backup

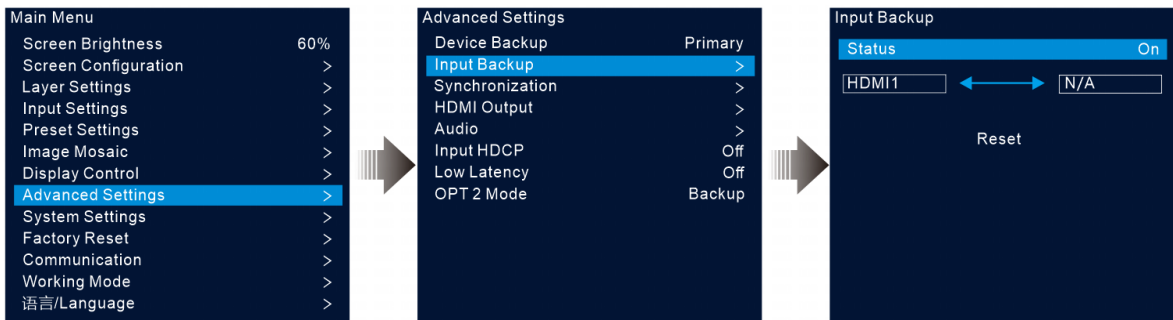

Step 2 Rotate the knob to select **Status** and press the knob to confirm. Rotate the knob again to select **On** and press the knob to confirm.

Step 3 Rotate the knob to select the desired input source on the right side.

Input backup rules:

- In the backup group, two HDMI sources serve as the backup for each other.
- Restrictions on input backup functions:
  - HDMI 1 and HDMI 2 form a hot backup group. The current input source of the layer is HDMI 1.
    - HDMI 1: No signal. HDMI 2: Signal



The layer input source is switched to HDMI 2 automatically. When HDMI 1 resumes and HDMI 2 still has a signal, the layer input source will not be changed.

- HDMI 1: No signal. HDMI 2: Signal

The layer input source is switched to HDMI 2 automatically. When HDMI 1 resumes, but HDMI 2 does not have a signal, the layer input source will be changed to HDMI 1.

- HDMI 1: No signal. HDMI 2: No signal

The layer input source will not be changed.

- HDMI 1: Signal. HDMI 2: No signal

If you manually switch the layer input source to HDMI 2, the source will automatically switch to HDMI 1.

### 5.8.3 Synchronization

This function allows you to select a synchronization signal to synchronize all the cascaded device units or synchronize the primary and backup devices to display the output images of all the units in sync.

- Step 1 On the main menu screen, go to **Advanced Settings > Synchronization** to enter the synchronization settings screen.

Figure 5-32 Synchronization

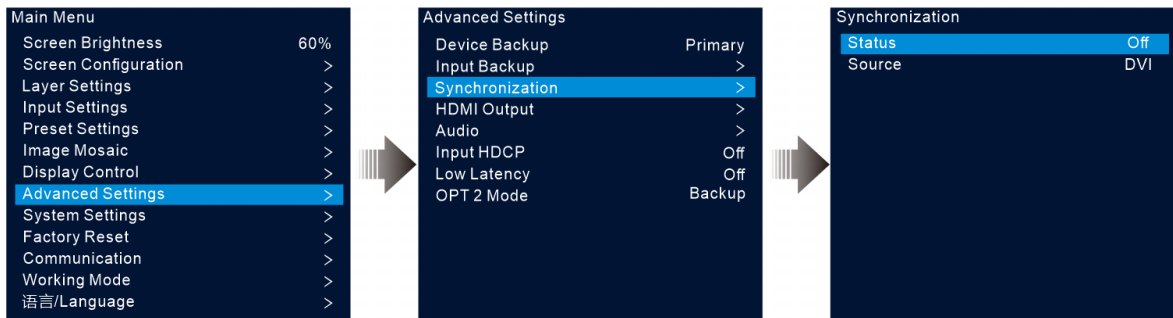

- Step 2 Rotate the knob to select **Status** and press the knob to confirm. Rotate the knob again to select **On** and press the knob to confirm.
- Step 3 Rotate the knob to select **Source** and press the knob to confirm. Then rotate the knob again to select the desired sync source.

**Note:**

If two or more VX400 units load an LED screen, the sync sources used by each device must be the same.

### 5.8.4 HDMI Output

The HDMI output connector can be used for output. When the HDMI connector is used for output, its output resolution can be adjusted, but the Ethernet output will be affected.

The following resolutions are supported on the HDMI output connector.

- 1024x768@48/50/59.94/60/75/85Hz
- 1280x720@23.98/24/25/29.97/30/48/50/59.94/60Hz
- 1280x1024@48/50/59.94/60/75/85Hz
- 1366x768@50/59.94/60Hz
- 1440x900@60/75/85Hz
- 1600x1200@48/50/59.94/60Hz
- 1680x1050@60Hz

- 1920x1080@23.98/24/25/29.97/30/48/50/59.94/60Hz
- 1920x1200@50/59.94/60Hz

Figure 5-33 HDMI output

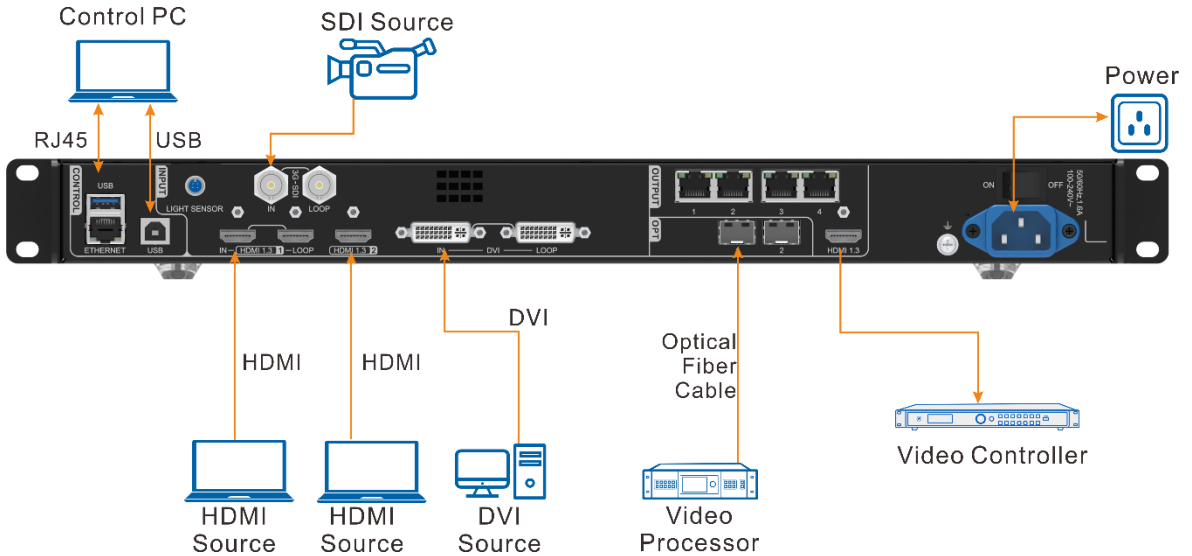

Step 1 On the main menu screen, go to **Advanced Settings > HDMI Output** to enter the HDMI output settings screen.

Figure 5-34 HDMI output

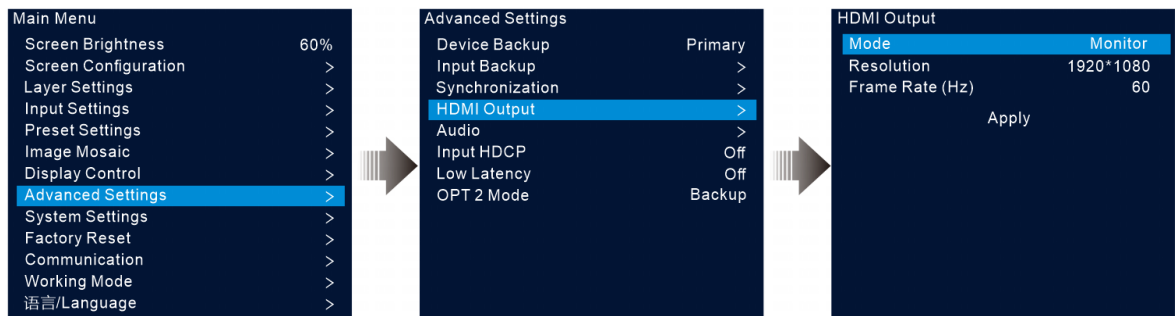

Step 2 Rotate the knob to select **Mode** to set the HDMI output connector mode.

HDMI output connector supports **Monitor** and **Video Output** modes.

- **Monitor:** The image displayed on the LED screen will be appropriately processed based on the resolution and frame rate of the HDMI output connector, so that the device connected to the VX400 can properly receive the image.
- **Video Output:** Process and output the received image directly.

Step 3 Select **Resolution** to set the desired resolution for the connector.

Step 4 Rotate the knob to select **Frame Rate (Hz)** to set the desired frame rate for the connector.

Step 5 Rotate the knob to select **Apply** to make the settings take effect.

### 5.8.5 Audio

This function allows you to set the audio output, audio volume and input audio.

The VX400 supports audio connection via a multifunction card. Connect the Ethernet port 1 or 2 to a multifunction card, and then connect the multifunction card to an external speaker.

Figure 5-35 Audio output connection

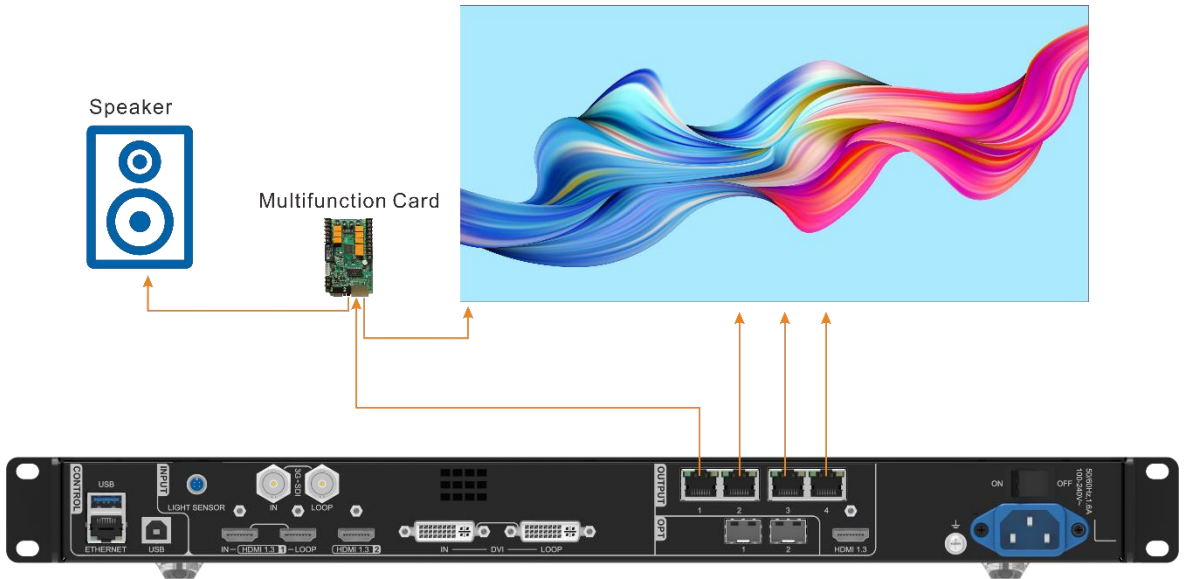

On the main menu screen, go to **Advanced Settings > Audio** to enter the audio settings screen.

Figure 5-36 Audio settings

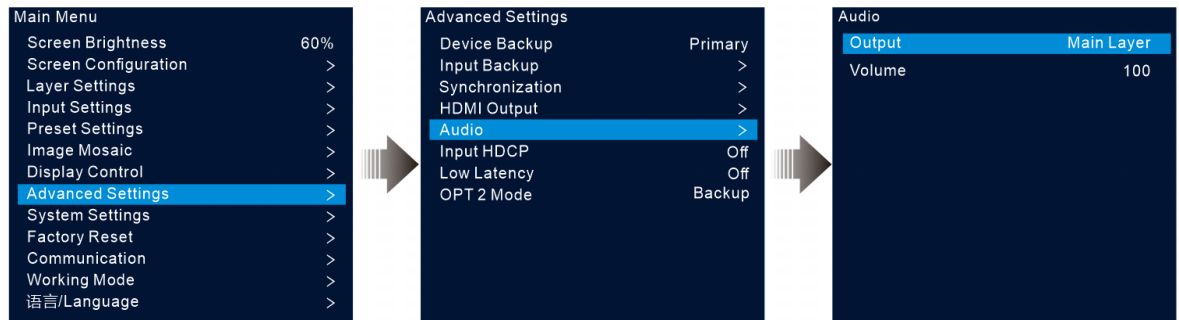

### 5.8.5.1 Output

Set to play which audio on the external speaker.

Step 1 On the audio settings screen, rotate the knob to select **Output**.

Step 2 Press the knob to open the available output list and rotate the knob to select where the output audio is from.

Figure 5-37 Audio output

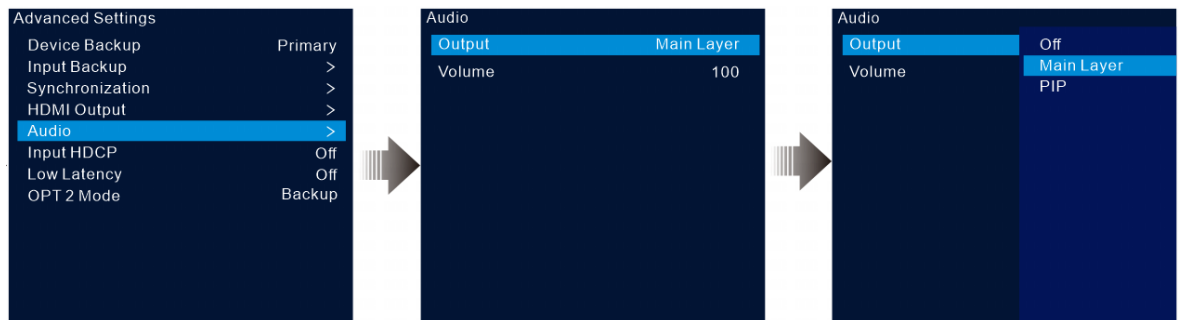

- Off: Turn off the audio.
- Main Layer/PIP: Play the audio that comes with the main layer or PIP.

Step 3 Press the knob to complete the selection.

### 5.8.5.2 Volume

Adjust the audio volume.

The value ranges from 0 (silent) to 100 (loudest) and defaults to 50.

On the audio settings screen, rotate the knob to select **Volume** and press the knob to confirm. Then rotate the knob again to adjust the audio volume and press the knob to confirm.

### 5.8.6 Input HDCP

High-bandwidth Digital Content Protection (HDCP) is a form of digital copy protection to prevent digital audio and video content copying as it travels across connections. When the accessed input source is an HDCP-encrypted one, you need to turn on this function to enable the device to transmit and process the source.

On the main menu screen, go to **Advanced Settings > Input HDCP** and press the knob to enable the settings. Then rotate the knob again to select **On** or **Off** and press the knob to confirm the selection.

- On: Turn on the transmission and processing functions for the input source.
- Off: Turn off the transmission and processing functions for the input source.

### 5.8.7 Low Latency

When the input source travels from where it comes to the processing device, sending device and then the receiving card, latency exists inevitably. Turning on this function can effectively help to reduce the latency from the input to output.

The VX400 can reduce the delay from the input to receiving card to as low as 1 frame when the low latency and synchronization functions are both turned on and the data runs vertically on the screen.

On the main menu screen, go to **Advanced Settings > Low Latency** and press the knob to confirm. Then rotate the knob again to select **On** or **Off** and press the knob to confirm the selection.

### 5.8.8 OPT 2 Mode

The VX400 provides two OPT ports that work in different modes.

- OPT 1 is used for input and output.
- OPT 2 is used for output only and copies or backs up the data on the 4 Ethernet ports.

On the main menu screen, go to **Advanced Settings > OPT 2 Mode** to enter the OPT port settings screen.

Figure 5-38 OPT 2 working mode

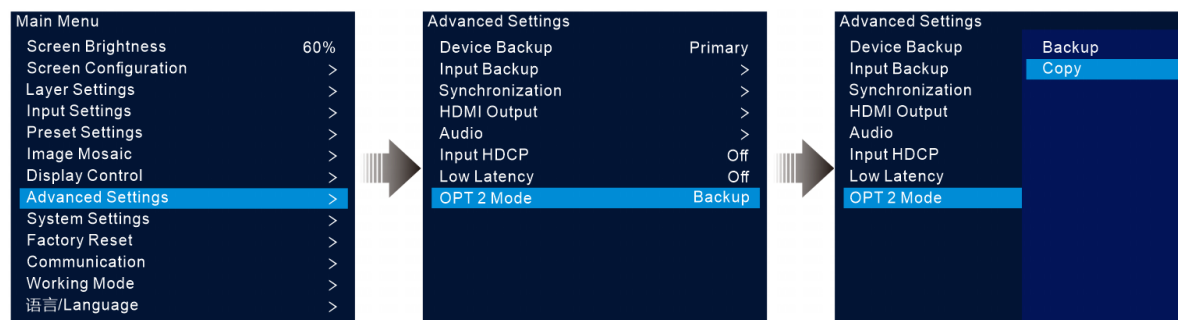

### Copy

The connections in the Copy mode are shown below.

In this mode, the data flow of the connected fiber converter is the same as that of the VX400.

Figure 5-39 Copy

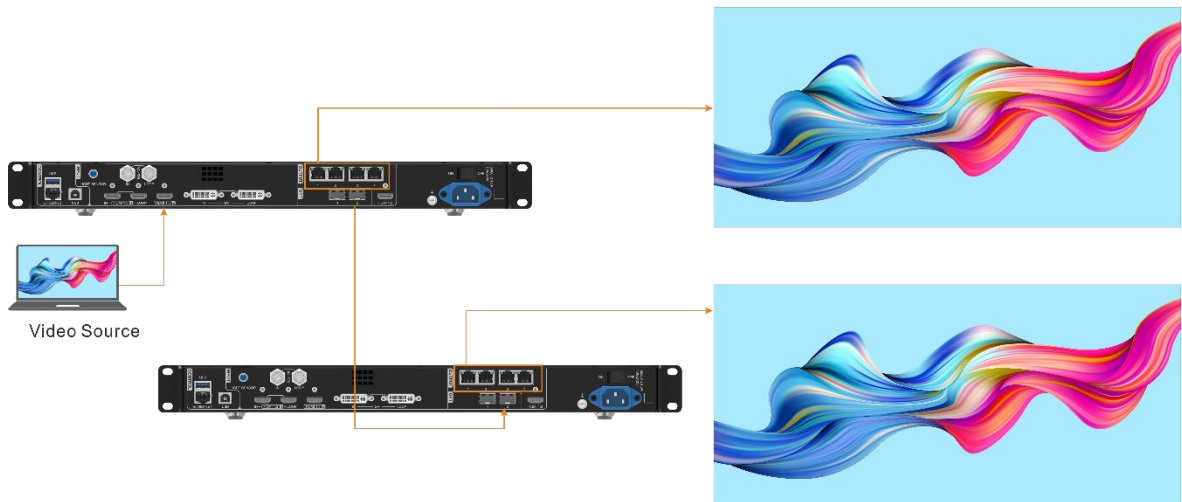

## Backup

The connections in the Backup mode are shown below.

Figure 5-40 Backup

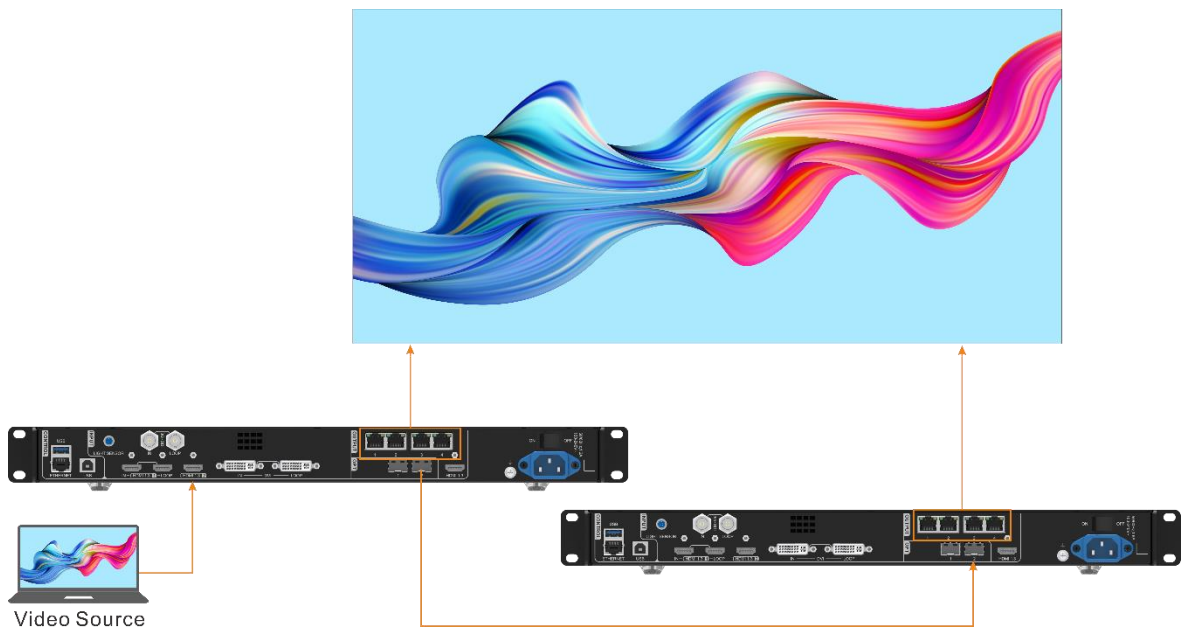

### Note:

When the OPT port works as the backup output port, OPT 2 is used for the connection. Firstly set the OPT 2 mode to **Backup**, and then make all the connections as shown above. Please pay attention to the Ethernet port backup relations between the backup device and the primary device.

## 5.9 System Settings

The system settings allow you to set the Fn shortcut button, return to home time, diagnose the device, and view other related information.

### 5.9.1 Fn

This function allows you to set a shortcut button for an assigned function. By using the Fn button, you can quickly navigate to the target menu screen and never need to access a specified menu item by entering the menus level by level.

On the main menu screen, go to **System Settings > Fn** and press the knob to enter the Fn button settings screen. Rotate the knob to select the desired function and press the knob to confirm.

Figure 5-41 Fn button settings

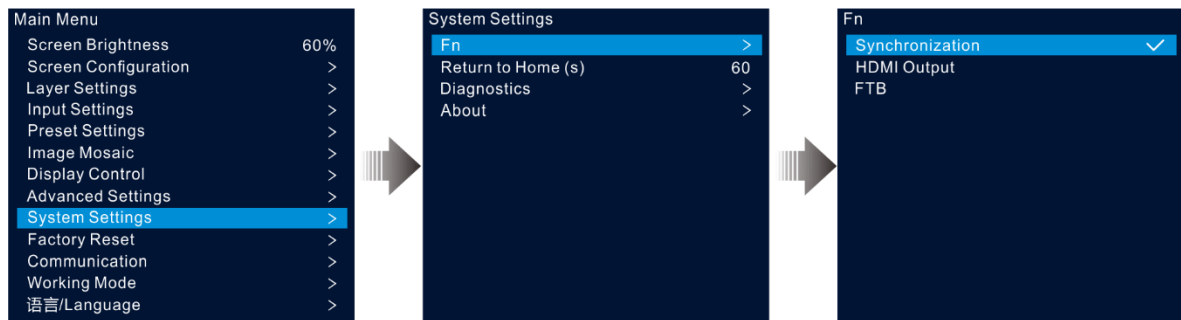

### 5.9.2 Return to Home (s)

You can set the period when the system stays at the current screen before returning to the homepage automatically when no operation is performed. The value ranges from 60s to 3600s.

On the main menu screen, go to **System Settings > Return to Home (s)** and press the knob to confirm. Rotate the knob to select the desired time value and press the knob to confirm.

### 5.9.3 Diagnostics

The diagnostics function helps you to diagnose the system and troubleshoot the malfunctioned device components.

- When the device fails, you can run the diagnostics function to test the device. You can send your test to our technical support staff for problem locating and processing.
- For daily maintenance, you can run the diagnostics function to do the routine health check for the system.

On the main menu screen, go to **System Settings > Diagnostics** and press the knob to open the confirmation window. Rotate the knob to select **Yes** and press the knob to confirm.

---

#### Note:

Running diagnostics will transiently disrupt the output, and the output will resume after the diagnostics are completed.

---

### 5.9.4 About

Under this menu item, you can view the firmware version, official website and email address. On our official website, you can check the latest device information and the updates for this device. You can also send your feedback or suggestion to us for improvements via the supplied email address.

On the main menu screen, go to **System Settings > About** and press the knob to show all the information.

Figure 5-42 About

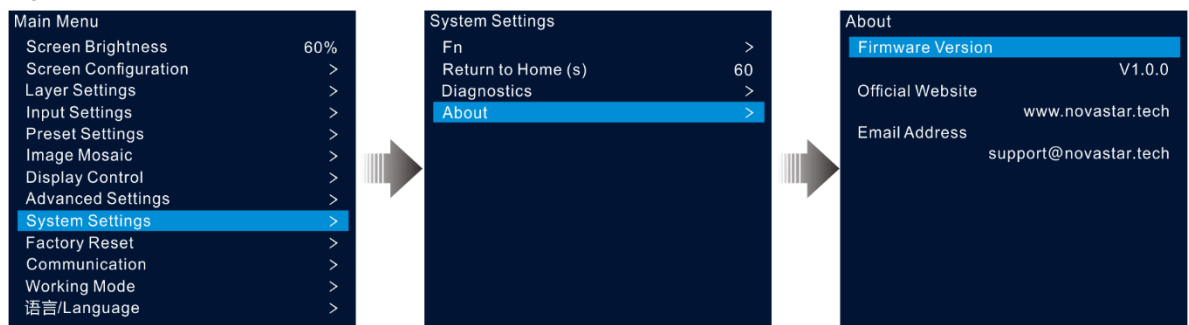

## 5.10 Factory Reset

Factory reset function allows you to reset all the parameter settings of the device to factory defaults after the device update or when you think the parameters are improperly set.

On the main menu screen, rotate the knob to select **Factory Reset** and press the knob to enter the factory reset screen.

Figure 5-43 Factory reset

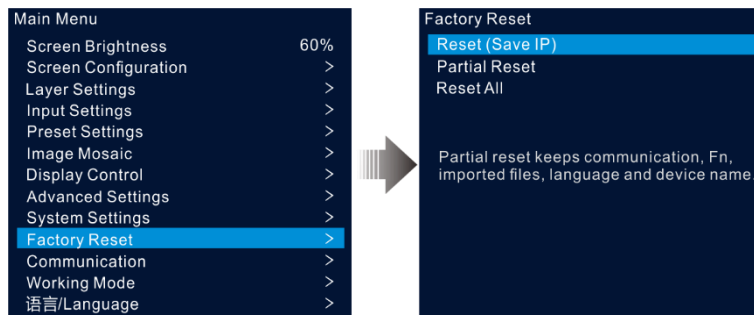

- **Reset (Save IP):** Reset the parameter settings to factory defaults, except for the communication parameter settings.
- **Partial Reset:** Reset the parameter settings to factory defaults, except for the communication, Fn and language settings, imported files and device name.
- **Reset All:** Reset all the parameter settings to factory defaults.

## 5.11 Communication Settings

You can set the communication and network information to enable the device to communicate with the control PC smoothly.

### 5.11.1 Set Communication Mode

The VX400 can communicate with the control PC via either the Ethernet cable or USB cable. If the device is connected to the control PC via both the Ethernet cable and USB cable, you can select your preferred communication channel.

- Step 1 On the main menu screen, rotate the knob to select **Communication** and press the knob to enter the communication settings screen.

Figure 5-44 Communication mode

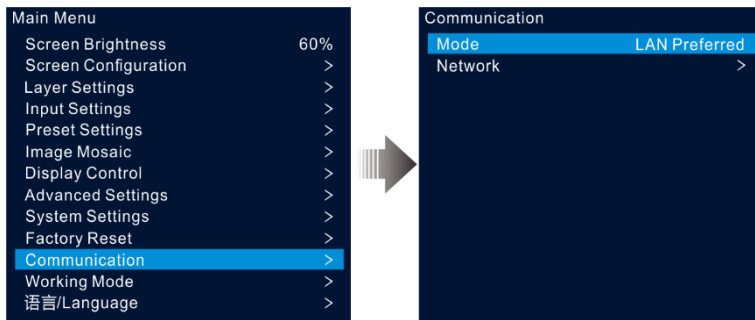

Step 2 Rotate the knob to select **Mode** and press the knob to confirm. Rotate the knob again to select the desired mode and press it to confirm.

The options include **LAN Preferred** and **USB Preferred**.

- LAN Preferred: The device communicates with the control PC via the Ethernet cable.
- USB Preferred: The device communicates with the control PC via the USB cable.

### 5.11.2 Set Network Parameters

When the **LAN Preferred** option is selected, you must set the device IP address, subnet mask and gateway. Ensure that the device and the control PC are on the same network segment and the device IP address must not conflict with the IP address of the control PC.

Step 1 On the main menu screen, rotate the knob to select **Communication** and press the knob to enter the communication settings screen.

Step 2 Rotate the knob to select **Network** and press the knob to enter the network settings screen.

Figure 5-45 Network settings

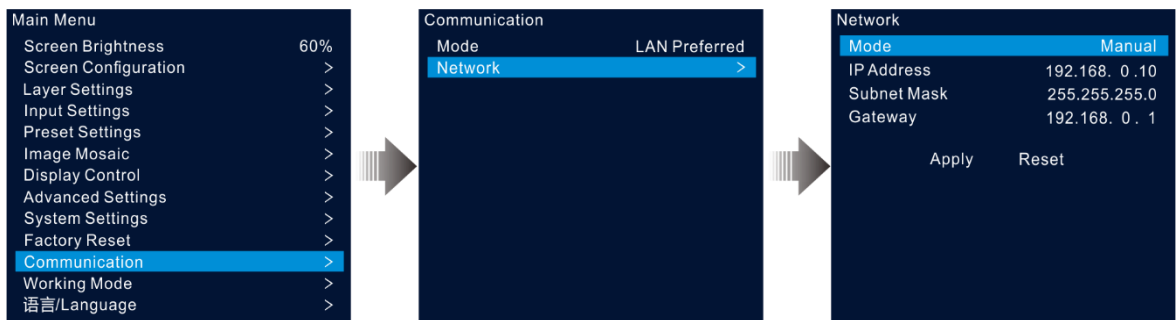

Step 3 Select **Mode** and press the knob to confirm.

The options include **Manual** and **Automatic**.

- Manual: Set the device IP address, subnet mask and gateway manually.
- Automatic: The system automatically assigns an IP address for the device. When the device and control PC are connected to the same router or switch, set this option to **Automatic**.

Step 4 When the **Manual** option is selected, you must manually set the device IP address, subnet mask and gateway.

Step 5 Rotate the knob to select **Apply** to make the settings take effect; otherwise, select **Reset** to reset the settings to defaults.



## 5.12 Working Mode

The VX400 supports three working modes, including Video Controller, Fiber Converter and Bypass. On the main menu screen, select **Working Mode** to enter the working mode settings screen.

Figure 5-46 Working mode

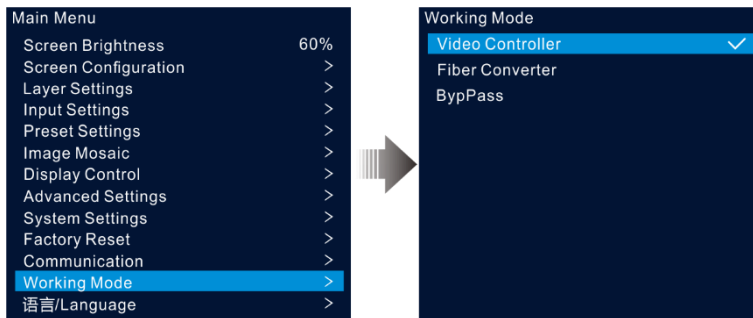

### Video Controller

- OPT 1 can be used as an input or output connector depending on the connected downstream devices.
  - When the device is connected to a video processor, OPT 1 is used as an input connector.
  - When the device is connected to a fiber converter or a device working under the Fiber Converter mode, OPT 1 is used as an output connector.
- The HDMI1.3 output connector is used for monitoring with a fixed resolution of 1920×1080@60Hz when connected to a monitor. If you change the output resolution of this connector, the device will work as a video processor and the image output by Ethernet ports will be incomplete.
- Under this mode, all the LCD menus are available.

### Fiber Converter

- OPT 1 and OPT 2 are both used as the input connectors.
  - All Ethernet ports output the data that OPT 1 transmits.
  - When OPT 1 and OPT 2 are accessed with different data, the Ethernet ports transmit OPT 1 data. When OPT 1 data is lost, OPT2 data will be used seamlessly; when OPT 1 data resumes, OPT 1 data be used as usual again.
- Under this mode, only **Working Mode**, **Communication Settings** and **语言/Language** menus are available.

### Bypass

Under this mode, the device works as an independent controller with no support for video processing functions.

Only the main layer can be used, and the PIP layer is unavailable.

## 5.13 Language

The language options include English and Simplified Chinese. You can switch to your preferred language.

## 6 Device Update

The VX400 allows you to update the firmware in V-Can.

### 6.1 Obtain Firmware Update Package

Visit NovaStar's official website at [www.novastar.tech](http://www.novastar.tech), and then go to **DOWNLOADS > Processors > VX400 > Firmware**. Click **Download** to download and save the latest software package to your local hard drive.

### 6.2 Firmware Update

#### Device Connection

You can update the VX400 in V-Can or NovaLCT only.

Before the update, use an Ethernet cable to connect the device to the control PC with V-Can installed, as shown in the below figure.

Figure 6-1 Hardware connection

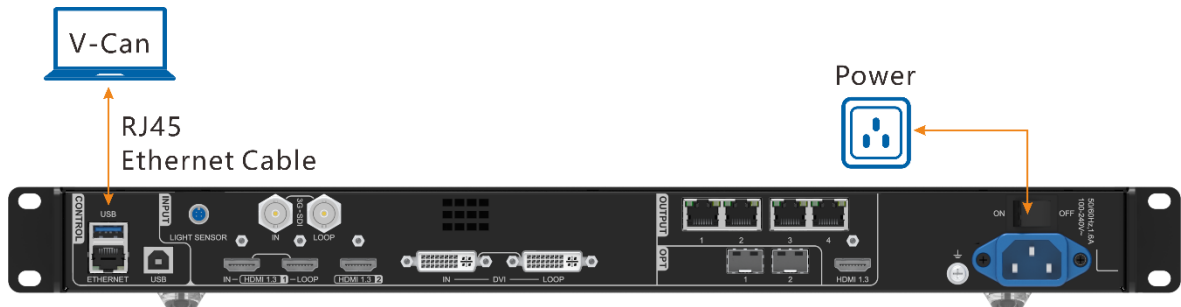

#### Firmware Update in V-Can

- Step 1 Decompress the downloaded firmware package.
- Step 2 Start the V-Can software.
- Step 3 Go to **System > Firmware Update** to enter the update page.

Figure 6-2 Firmware update

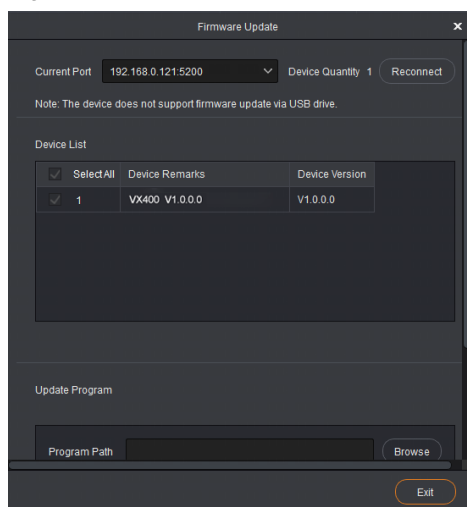

- Step 4 Click **Browse** in the **Update Program** area to open a window where you can select the location of the downloaded firmware package.

**Note:**

If you need to update multiple devices, check the boxes next to the desired devices in the **Device List** area.

- Step 5 Click **OK** to add the update package.
- Step 6 Click **Update** to start the update process.
- Step 7 After the update, you can check whether the device is the latest version in the **Device List** area.
- Yes => Go to [Step 8](#).
  - No => Contact our technical support staff to find out the reason and update the device again.
- Step 8 Click **Exit** to exit the update page.

## Firmware Update in NovaLCT

- Step 1 Run NovaLCT.
- Step 2 Go to **User > Advanced Synchronous System User Login**, enter the password (default: “admin”) and click **Login**.
- Step 3 Type the secret code “**admin**” to open the program loading page.

Figure 6-3 Program loading

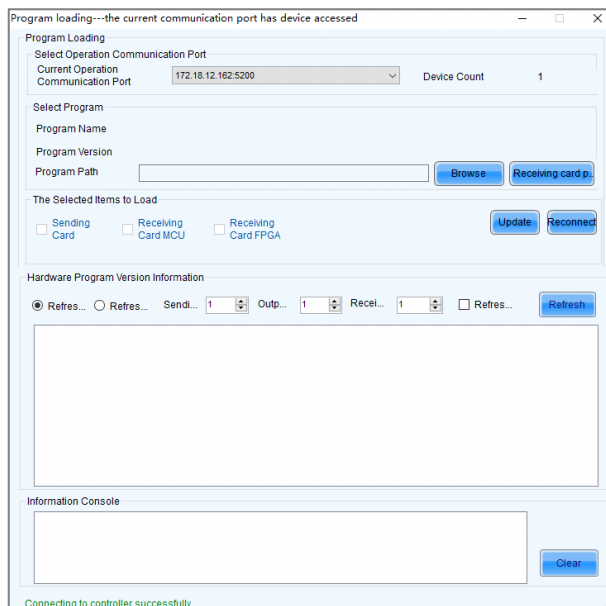

- Step 4 Click **Browse** and select the program package.
- Step 5 Click **Update** and the system will update the VX400 firmware program.
- Step 6 After the update, the VX400 will restart automatically.
- Step 7 After the update, click **Refresh** under **Hardware Program Version Information** to check whether the version is the one after updated.
- Yes => Go to [Step 8](#).
  - No => Contact the device’s technical support and troubleshoot the problem. Then, update firmware again.
- Step 8 Close the program loading page.

# 7 Device Backup/Restore

## 7.1 Device Backup

You can back up the device configuration to your local computer and restore it when needed.

### Prerequisites

- You have made the necessary device configuration.
- You have connected the device to the control PC with V-Can installed via the Ethernet cable.

### Operating Procedure

- Step 1 In V-Can, go to **System > Backup** to open the backup window.
- Step 2 Click **Export**.
- Step 3 Select a local path to save the backup file.
- Step 4 Enter a name for the backup file.
- Step 5 Click **Open** to complete the backup.

---

**Note:**

The default name of the backup file is "Device model-YMD-hour-minute-uback.img". You can rename the file, but you cannot change the filename extension.

---

## 7.2 Device Restore

You can restore the backup information on your local computer to the device for quick device configuration.

### Prerequisites

- You have connected the device to the control PC with V-Can installed via the Ethernet cable.
- There is a device backup file on the control PC.

### Notes

After the restoration, the device will restart automatically.

### Operating Procedure

- Step 1 Go to **System > Restore** to open the restore window.
- Step 2 Click **Import**.
- Step 3 Select the local path where the backup file is saved.
- Step 4 Select the backup file.
- Step 5 Click **Open** to complete the restoring.

# 8 Screen Brightness Adjustment

The VX400 supports automatic brightness adjustment of the LED screen based on the ambient brightness collected by the light sensor.

## Prerequisites

- The VX400 is connected to a light sensor.
- NovaLCT V5.4.4.6 or later software is installed on the control PC.

## Operating Procedure

- Step 1 In NovaLCT, go to **User > Advanced Synchronous System User Login** and log in to NovaLCT.
- Step 2 Click **Brightness** or go to **Settings > Brightness** to open the brightness configuration page.
- Step 3 Select **Auto Adjustment** to open the automatic brightness adjustment page.

Figure 8-1 Brightness adjustment

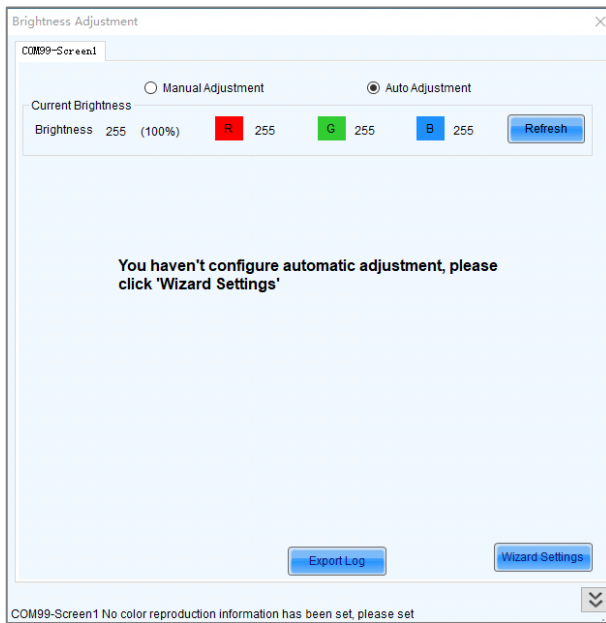

- Step 4 Click **Wizard Settings** to open the adjustment type settings page.

Figure 8-2 Setting adjustment type

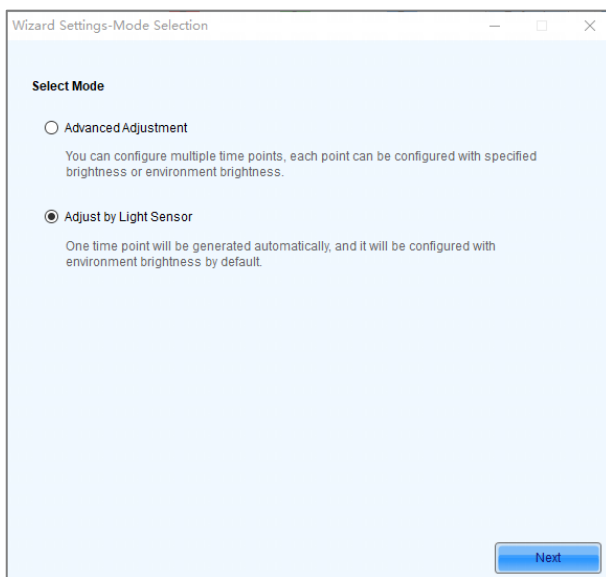

- Step 5 Select **Adjust by Light Sensor** and click **Next** to open light sensor settings page.

Figure 8-3 Light sensor settings

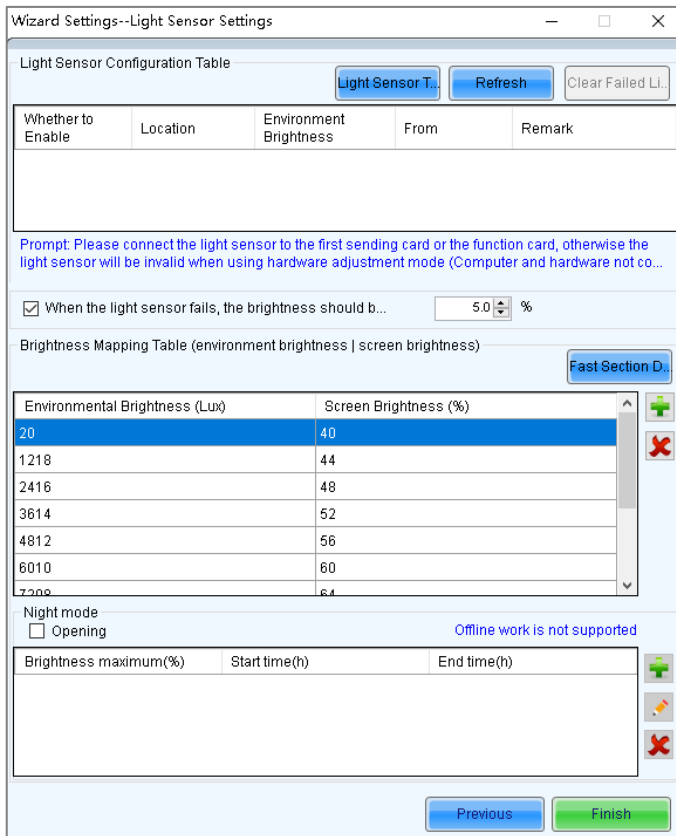

- **Light Sensor Test:** Test the light sensors connected to the control system, including the light sensors connected to all sending cards and multifunction card.
- **Refresh:** Refresh the connection status of the light sensors to handle the situation that new light sensors are connected or the light sensors are disconnected.
- **Clear Failed Light Sensor Information:** Clear the light sensors that you do not use.

Step 6 Select the light sensors to enable them.

Step 7 Select **When the light sensor fails, the brightness should be adjusted to** and set a brightness value.

If this function is not enabled, when the light sensor fails, the brightness keeps the last updated value.

Step 8 Click **Fast Section Division** to open the fast section division configuration page.

Fast section division can equally divide the ambient brightness range and screen brightness range into the specified number of segments. The software can adjust the actual screen brightness to a value between the set screen brightness segment according to the corresponding current ambient brightness.

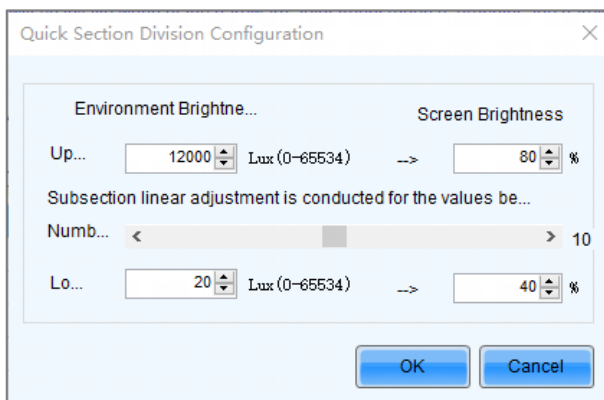

Figure 8-4 Fast section configuration



- **Upper Limit:** The maximum ambient brightness; screen brightness: the screen brightness corresponding to the maximum ambient brightness

- Number of Subsections: The number of segments of ambient brightness between the maximum and minimum ambient brightness
- Lower Limit: The minimum ambient brightness; screen brightness: the screen brightness corresponding to the minimum ambient brightness

Step 9 Click **OK** to complete brightness section settings. The sections and the corresponding brightness values will be shown in the table on the light sensor settings page.

- Click  to add a section for the relation between the ambient brightness and screen brightness.
- Click  to delete the selected section.

Step 10 Select **Opening** to enable the automatic adjustment mode at night.

The night mode control the screen brightness at night. When surrounding lights interfere with the light sensor or an exception occurs when the light sensor is collecting ambient brightness data, screen brightness may be too high. This can be avoided in night mode.

In night mode, when the screen brightness adjusted according to the ambient brightness collected by the light sensor is higher than the set maximum brightness for night mode, the system will adjust the screen brightness to the maximum brightness for night mode, otherwise, the system will automatically adjust the screen brightness according to the brightness mapping table.

1. Select **Opening** to enable night mode.
2. Click  to add night mode setting options, including **Start time**, **End time**, and **Brightness maximum**.

Figure 8-5 Adding the night mode



- Start time: Set when the night mode starts.
- End time: Set when the night mode ends.
- Brightness maximum: Set the maximum screen brightness in night mode.

3. Click **OK** to complete night mode settings.

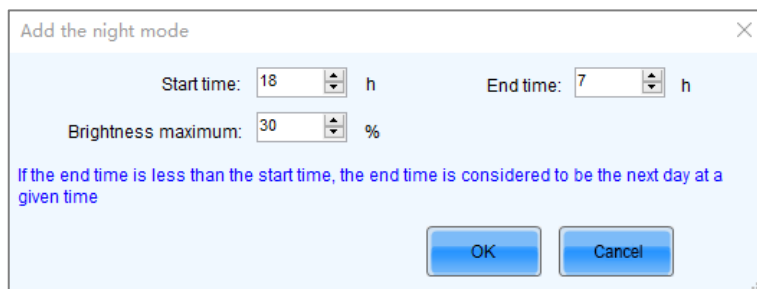
Step 11 Click **Finish** to complete light sensor brightness adjustment configuration.

Step 12 Click **Save** to make the light sensor configuration parameters take effect.

Step 13 Set the effective time for the automatic brightness adjustment.

1. On the task bar, right click the MonitorSite icon and choose **Brightness Advanced Settings**.

Figure 8-6 Brightness settings

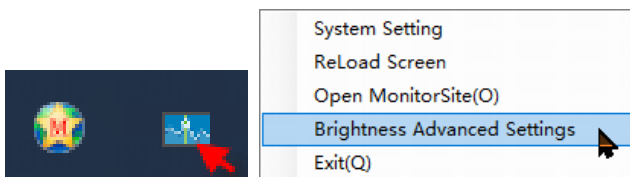

2. Select **Enable Brightness Gradient**.

Figure 8-7 Advanced brightness settings

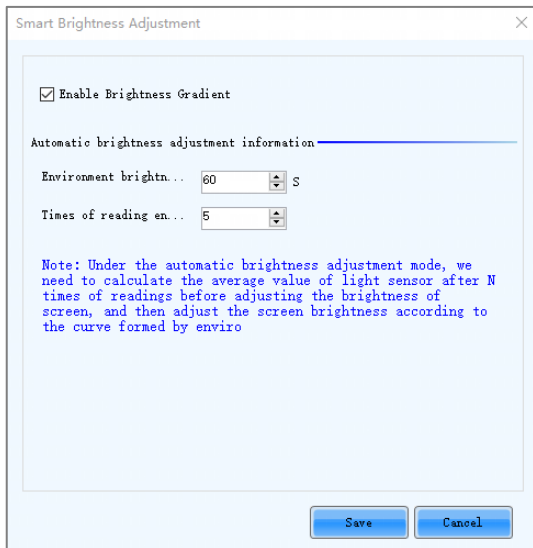

- Under **Automatic brightness adjustment information**, set **Environment brightness detecting cycle** and **Times of reading environment brightness**.

The effective time for automatic brightness adjustment = Environment brightness detecting cycle × Times of reading environment brightness.

For example, if the cycle is 60 seconds and number of times is 5, the effective time for automatic brightness adjustment is 5 minutes.

## 9 Specifications

Electrical Parameters	Power connector	100–240V~, 1.6A, 50/60Hz
	Rated power consumption	28 W
Operating Environment	Temperature	0°C to 45°C
	Humidity	20% RH to 90% RH, non-condensing
Storage Environment	Temperature	–20°C to +70°C
	Humidity	10% RH to 95% RH, non-condensing
Physical Specifications	Dimensions	483.6 mm × 301.2 mm × 50.1 mm
	Net weight	4 kg
Packing Information	Accessories	1x Power cord 1x HDMI to DVI cable 1x USB cable 1x Ethernet cable 1x HDMI cable 1x Quick Start Guide 1x Certificate of Approval 1x Safety Manual
	Packing size	550.0 mm × 175.0 mm × 400.0 mm
	Gross weight	6.8 kg



Noise Level (typical at 25°C/77°F)	45 dB (A)
------------------------------------	-----------

## 10 Video Source Features

Input Connectors	Bit Depth		Max. Input Resolution
<ul style="list-style-type: none"> <li>• HDMI 1.3</li> <li>• DVI</li> <li>• OPT 1</li> </ul>	8-bit	RGB 4:4:4	1920x1200@60Hz (Standard)
		YCbCr 4:4:4	3840x648@60Hz (Custom)
		YCbCr 4:2:2	600x3840@60Hz (Forced)
		YCbCr 4:2:0	Not supported
	10-bit		Not supported
	12-bit		Not supported
3G-SDI	<ul style="list-style-type: none"> <li>• Max. input resolution: 1920x1080@60Hz</li> <li>• DOES NOT support input resolution and bit depth settings.</li> <li>• Supports ST-424 (3G), ST-292 (HD) and ST-259 (SD) standard video inputs.</li> </ul>		

## 11 Notes and Cautions

### Notes For Battery

- The battery is not intended to be replaced.
- Disposal of a battery into fire or a hot oven, or mechanically crushing or cutting of a battery can result in an explosion.
- Leaving a battery in an extremely high temperature surrounding environment can result in an explosion or the leakage of flammable liquid or gas.
- A battery subjected to extremely low air pressure may result in an explosion or the leakage of flammable liquid or gas.

### Notes For Installation

When the product needs to be installed on the rack, 4 screws at least M5\*12 should be used to fix it. The rack for installation shall bear at least 32kg weight.

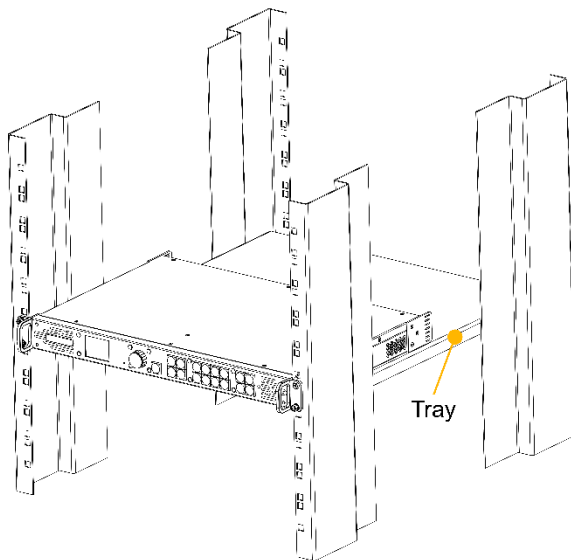

- Elevated Operating Ambient - If installed in a closed or multi-unit rack assembly, the operating ambient temperature of the rack environment may be greater than room ambient. Therefore, consideration should be given to installing the equipment in an environment compatible with the maximum ambient temperature (T<sub>ma</sub>) specified by the manufacturer.
- Reduced Air Flow – Installation of the equipment in a rack should be such that the amount of air flow required for safe operation of the equipment is not compromised.
- Mechanical Loading – Mounting of the equipment in the rack should be such that a hazardous condition is not achieved due to uneven mechanical loading.
- Circuit Overloading – Consideration should be given to the connection of the equipment to the supply circuit and the effect that overloading of the circuits might have on overcurrent protection and supply wiring. Appropriate consideration of equipment nameplate ratings should be used when addressing this concern.

Reliable Earthing – Reliable earthing of rack-mounted equipment should be maintained. Particular attention should be given to supply connections other than direct connections to the branch circuit (e.g. use of power strips).

**Copyright © 2022 Xi'an NovaStar Tech Co., Ltd. All Rights Reserved.**

No part of this document may be copied, reproduced, extracted or transmitted in any form or by any means without the prior written consent of Xi'an NovaStar Tech Co., Ltd.

### **Trademark**

 is a trademark of Xi'an NovaStar Tech Co., Ltd.

### **Statement**

Thank you for choosing NovaStar's product. This document is intended to help you understand and use the product. For accuracy and reliability, NovaStar may make improvements and/or changes to this document at any time and without notice. If you experience any problems in use or have any suggestions, please contact us via the contact information given in this document. We will do our best to solve any issues, as well as evaluate and implement any suggestions.

| [Official website](http://www.novastar.tech)  
| [www.novastar.tech](http://www.novastar.tech)

| [Technical support](mailto:support@novastar.tech)  
| [support@novastar.tech](mailto:support@novastar.tech)